

ISSN 1198-6727



# **Fisheries Centre Research Reports**

---

*2018 Volume #26 Number #2*

## **Marine and Freshwater Miscellanea**

---

**Institute for the Oceans and Fisheries,  
The University of British Columbia, Canada**

Please cite as:

**Pauly, D.; Ruiz-Leotaud, Valentina (2018) Marine and Freshwater Miscellanea. Fisheries Centre Research Reports 26(2): 83 pp.**

© Institute for the Oceans and Fisheries, The University of British Columbia, 2018  
Fisheries Centre Research Reports are Open Access publications  
ISSN 1198-6727

Institute for the Oceans and Fisheries  
University of British Columbia,  
2202 Main Mall,  
Vancouver, BC, V6T 1Z4.

This research report is indexed in Google Scholar, Research Gate, the UBC library archive (cIRcle).

## Table of Contents

<b>Director's Foreword</b> .....	3
<b>Preface</b> .....	4
<b>The Future of Marine Fisheries</b> .....	5
Heike K. Lotze, Rainer Froese and Daniel Pauly	
<b>A Tribute to Walter Arndt</b> .....	14
Daniel Pauly	
<b>Electrophoretic Studies of Peruvian Anchoveta <i>Engraulis ringens</i> Confirm the Existence of Distinct North/Central and Southern Stocks</b> .....	16
Jaime Mendo	
<b>Localism vs. Universalism in Science: Vignettes from Fisheries Research</b> .....	27
Daniel Pauly	
<b>What are Global Fisheries Studies</b> .....	33
Daniel Pauly, William Cheung and U. Rashid Sumaila	
<b>The Coverage of Illegal Fishing in Turkish Newspapers</b> .....	38
Çetin Keskin and Yelda Aktan Turan	
<b>A Note on Ursin's Formulae for the Estimation of Natural Mortality in Fish Stocks</b> .....	40
Daniel Pauly	
<b>Estimation of Global Meiofauna and Macrofauna Biomass</b> .....	44
Aja Szumylo and Daniel Pauly	
<b>Learning from Peer-reviews: The Gill-Oxygen Limitation Theory and the Growth of Fishes and Aquatic Invertebrates</b> .....	53
Daniel Pauly	
<b>Mixed Reviews</b> .....	71
Daniel Pauly	

## Director's Foreword

This volume represents a vinegret\* of contributions covering a variety of fish and fishery related topics. It ranges from a very informal interpretation of forgotten data, through some focused and localized studies, to high-level overviews and philosophical opinions. One thing that unites them, besides co-authorship, is the will to showcase research that has been conducted but for whatever reason did not make into prime literature. As we researchers know, if something is not published, it usually does not exist. Yet, every bit of research requires human and funding investments, and if results and findings are not in the public domain and accessible to everyone, someone somewhere will do this again and spent resources which are always in a short supply. In my opinion, miscellaneous issues like this are a very good idea and should be a re-occurring phenomenon in the FCRR. I am fairly certain that every researcher would have dozens of documents that did not 'make the cut' for peer-reviewed literature, but do represent valuable pieces of research and an invaluable reference.

Prof. Evgeny Pakhomov  
Director, Institute for the Oceans and Fisheries  
The University of British Columbia

---

\* Vinegret or Russian vinaigrette is a salad that includes diced cooked vegetables (beetroots, potatoes, carrots, peas), chopped onions, as well as sauerkraut and pickles, all sprinkled with vegetable oil.

## **Preface**

This report is the third of a series presenting older, but possibly still interesting, papers that remained unavailable, complemented by more recent pieces not suitable for peer-reviewed journals, but including data or views that some readers may find useful.

However, while the earlier reports presented a wide diversity of authors, the majority of chapters in this report are authored or coauthored by one of us (D.P.) The only excuse that he thinks he has for this is that he is 72 years old and that he would not like to find, when he retires, too many manuscripts that he would have liked to share earlier.

Still, in spite of this quasi-monopoly, this report covers a wide range of topics, from the future of marine fisheries to the genetics of the Peruvian anchovy, and from the biomass of deep-sea benthos to fish respiration everywhere. Indeed, because D.P.'s view on the latter are different from those of mainstream physiologists, a contribution is presented on a topic that is rarely if ever, documented in details, i.e., the improvements to a paper that can result from thoughtful peer review.

Enjoy!

Daniel Pauly  
Valentina Ruiz-Leotaud

## THE FUTURE OF MARINE FISHERIES\*

Heike K. Lotze<sup>1</sup>, Rainer Froese<sup>2</sup> and Daniel Pauly<sup>3</sup>

<sup>1)</sup> Department of Biology, Dalhousie University, Halifax, Canada

<sup>2)</sup> GEOMAR Helmholtz-Zentrum für Ozeanforschung Kiel, Germany

<sup>3)</sup> Sea Around Us, Institute for the Oceans and Fisheries, 2202 Main Mall, University of British Columbia, Vancouver, Canada

[hlotze@dal.ca](mailto:hlotze@dal.ca), [rfroese@geomar.de](mailto:rfroese@geomar.de), [d.pauly@oceans.ubc.ca](mailto:d.pauly@oceans.ubc.ca)

### Abstract

Climate change is expected to change all aspects of life in the ocean, from basic biological processes such as survival and growth to the distribution and abundance of species, and the structure and function of marine food webs. These changes will affect fisheries and other ecosystem services. Many fishers will need to adapt to where and what they fish and how large, abundant and valuable their target species and overall catch are. Many species will move their distribution poleward or toward deeper waters. Some polar and tropical species may become extinct. This will lead to a restructuring of marine communities, with largely unpredictable consequences. Based on available climate projections, global fish production and catches are expected to decline, although with considerable regional variation, including increases in high and decreases in low latitudes. A large degree of future change, however, will depend on the development of fisheries and other human impacts. A reduction in fishing pressure, sustainable fisheries management and ocean governance will be necessary to maintain the future of fish and fisheries. The protection of marine biodiversity can thereby act as insurance in the face of climate and other global change.

### Introduction

The ocean hosts thousands of species of commercial importance, provides 17% of animal protein consumed by humans around the world and is a source of livelihoods for millions of people (FAO 2016). Yet the warming of the Earth's climate affects the physical, chemical and biological properties of the ocean that support fisheries and other benefits to humans. Increasing temperature and acidification, changing ocean circulation and stratification, melting sea ice, and rising sea level all influence the distribution, abundance, growth, and survival of marine life, from small plankton to large whales (Worm and Lotze 2016). Changes in individual organisms will affect populations, species interactions and food webs, which form the basis for the functioning of marine ecosystems and the services they provide to humans. Thus, understanding changes in marine life and biodiversity with climate change will help project the consequences for fish and fisheries in the future.

Over evolutionary time scales, climate change is nothing new to the ocean. Massive changes, including several mass extinctions have shaped marine biodiversity over millions of years (Harnik *et al.* 2012). Most of these changes were caused by changing temperatures (both warming and cooling) as well as ocean circulation, chemistry or productivity. Today, we are living through another episode of rapid climate change, yet this is not the only impact on marine biodiversity. Fisheries have and continue to exert significant pressure on ocean ecosystems around the globe (Pauly and Zeller 2016). There has also been a dramatic rise in habitat destruction, pollution, invasive species, and other human stressors, particularly in the coastal ocean (Lotze *et al.* 2006). Current increases in aquaculture, energy production and mining continue this trend in coastal and increasingly offshore and deep-sea ecosystems (Halpern *et al.* 2015). These cumulative stressors have already compromised marine biodiversity and fisheries in many places, potentially lowering their adaptive capacity to climate change. On the other hand, improvements in management and conservation have helped maintain marine biodiversity and ecosystem functioning in some regions. Thus, recent and potential future changes in climate are

---

\* Cite as Lotze, H., Froese, R., and Pauly, D. (2018) "The Future of Marine Fisheries," p. 5- 13. In Pauly D. and V. Ruiz-Leotaud (eds.) Marine and Freshwater Miscellanea. Fisheries Centre Research Reports 26(2). Institute for the Oceans and Fisheries, University of British Columbia. This is the original, English version of a book chapter published in German, i.e., Lotze, H, R. Froese and D. Pauly. 2016. Die Meeresfischerei der Zukunft, p. 284-290 In: J.L.Lozań, S.W. Breckle and E. Rachor (eds.). Warnsignal Klima – die Biodiversität. Verlag Wissenschaftlich Auswertungen/ GEO.

superimposed on a multitude of other human impacts with potentially complex interactions (Harley *et al.* 2006; Harnik *et al.* 2012). This is an important difference between previous and the current episode of climate change.

### Climate change in the ocean

Climate change has a range of effects on the marine environment that affect the basic survival, growth and distribution of marine life (Cheung *et al.* 2009; Worm and Lotze 2016). The most prominent physical changes include warming water temperatures and changes in ocean circulation, thermal stratification, sea level, and the extent of sea ice. Increased climatic variability can lead to more frequent extreme events, such as hurricanes or heat waves. The most prominent chemical changes are the increase in carbon dioxide causing ocean acidification and the reduction in subsurface oxygen concentrations due to warming and altered circulation. These changes in the abiotic environment affect all levels of biology, from the physiology of individual organisms to the growth of populations, the ecology of communities and the functioning of ecosystems (Figure 1). Yet all these levels of biology are needed to support fisheries and other ecosystem goods and services.

Changes in physical, chemical and biological processes can affect marine organisms and biodiversity directly or indirectly and act at different spatial and temporal scales (Worm and Lotze 2016). For example, when local temperatures exceed an individual's physiological tolerance, the individual may die or move away within hours or days. If such conditions become more common or extreme in a certain region, the population or species as a whole may shift its distribution over the following years or decades. Even if not directly affected by climate change, changes to its habitat, food availability or predator abundance can indirectly affect its growth or survival. All of this can alter the abundance, distribution, body size and health of species, including those important to commercial fisheries.

Range shifts have been observed and are predicted for many species, including phytoplankton, seaweeds, invertebrates, fish, and whales (Worm and Lotze 2016). In many temperate regions, warming has led to an increase in warm-adapted and decrease in cold-adapted species (Figure 2). This latitudinal shift can be altered by regional conditions and some species have moved into colder waters deeper or further offshore (Pinsky *et al.* 2013). In polar regions, warming leads to an invasion of cold-loving species, while species highly dependent on sea ice will suffer from melting ice sheets. In tropical regions, warming leads to the loss of species if maximum temperature tolerances are exceeded. On a global scale, these range shifts will result in an overall poleward shift of many species, with increasing species invasions into polar areas and species extinctions in tropical areas (Cheung *et al.* 2009).

Not all species will move poleward at the same pace (Figure 2); thus, there will be a re-structuring of local and regional communities and mismatches between predator and prey populations which are often hard to predict (Worm and Lotze 2016).

These changes can alter species interactions and food-web organization and create new winners and losers. Species thriving under the new abiotic and biotic conditions will increase, while those suffering will decline. Warming and reduced oxygen levels have also been shown to reduce body size of marine fishes (Sheridan and Bickford 2011; Cheung *et al.* 2013). Thus, individual body size as well as population size structure and biomass may be affected (Figure 2).

At an ecosystem level, climate change may alter the amount of primary production and with that the available organic matter and energy for higher trophic levels, leading to changes in secondary production or potential catch. On a global scale, most climate models predict a long-term decline in primary production over the 21<sup>st</sup> century, ranging from an average of -2% under a low to -8% under a high emission scenario by 2100 (Bopp *et al.* 2013). Yet there is considerable regional variation, with general increases in polar and decreases in tropical areas. However, global climate models don't predict changes in the coastal ocean very well, creating considerable variation and uncertainties in predictions depending on which climate model is used and at which spatial scale.

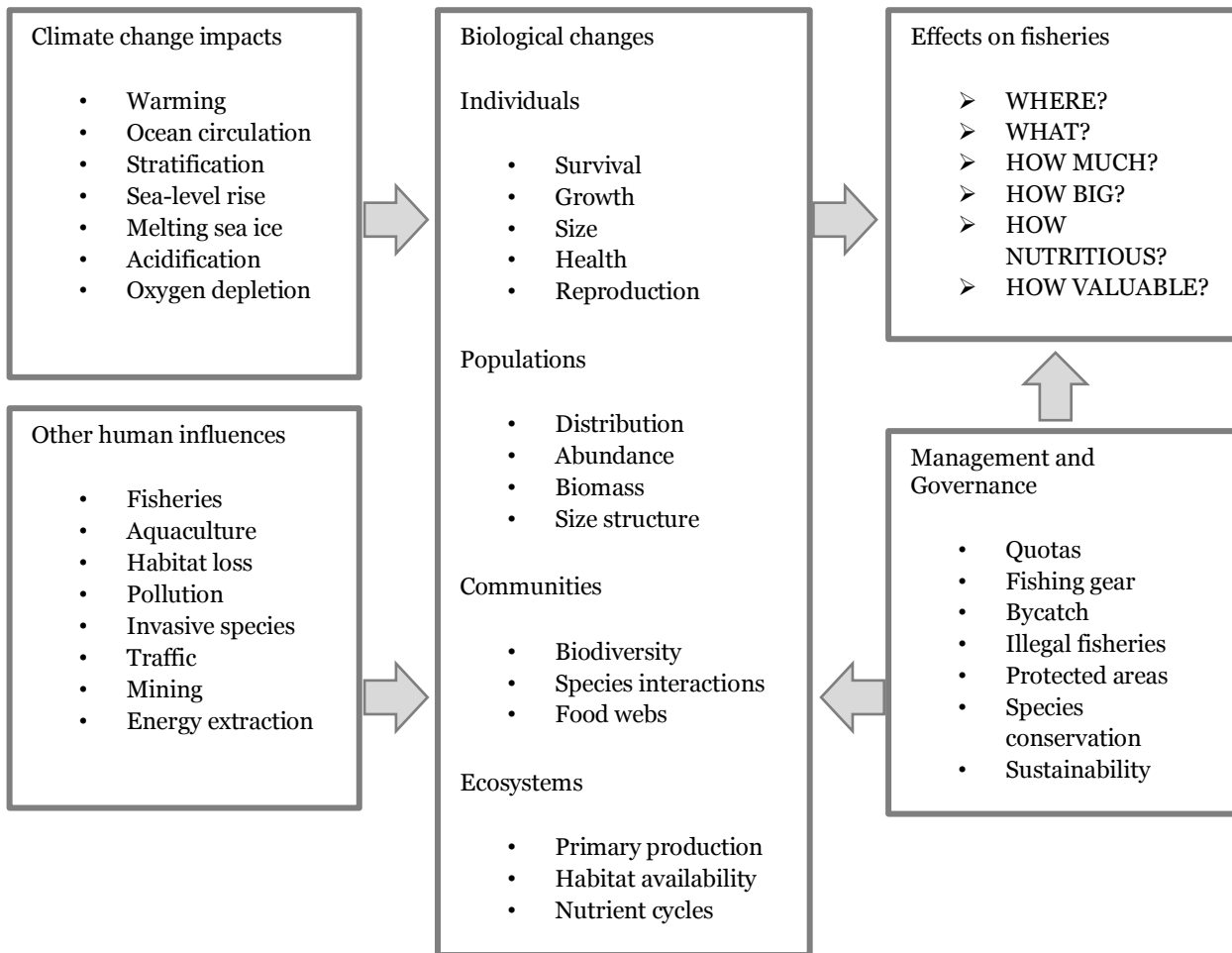

**Figure 1.** Overview on climate change impacts and other human influences on the biology of different levels of organization in the ocean and on fisheries as well as potential management and governance strategies to mitigate these changes.

Another important aspect of climate change is its effect on habitat availability, particularly in the coastal ocean. Many marine species depend on three-dimensional habitat for parts of their life cycle, including spawning, nursery, foraging and shelter from predation. Important habitat-providers, such as seagrasses, kelp, mangroves, and coral reefs are threatened by warming temperatures, sea level rise, acidification, and intense storms, with consequences for their associated fauna and flora (Worm and Lotze 2016). Many of these species also contribute to shoreline protection, nutrient cycling, carbon storage, oxygen and primary production and are thus important for ecosystem functions and services.



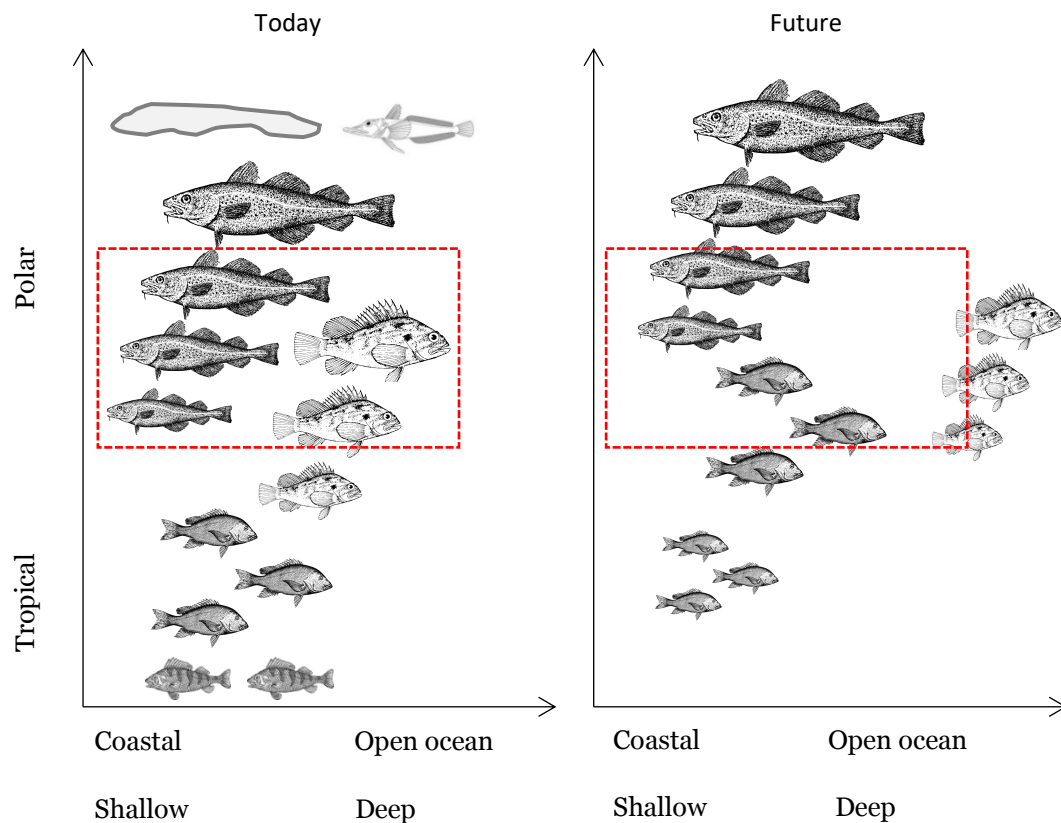

**Figure 2.** Summary of expected changes in fish communities with climate change: some tropical and ice-dependent species will likely go extinct, cold-adapted species will shift their distribution poleward or into deeper or more offshore waters, warm-adapted species will expand their distribution, and some species may become smaller. In a distinct ocean region (red box) the species- and size composition may therefore completely change with consequences for local fisheries (after Cheung *et al.* 2013).

Many studies focus on the effects of warming temperatures, but other climate-related factors are also important in influencing marine life and biodiversity on local, regional and global scales. For many open ocean animals, the availability of thermal fronts that concentrate food is of great importance, as is the availability of sufficient oxygen concentrations in deeper waters. Changing ocean circulation and currents can affect species movement and migration patterns, and changes in areas of high productivity and upwelling can affect food availability (Worm and Lotze 2016).

Importantly, many of these changes do not occur in isolation but act cumulatively on individual organisms and marine ecosystems as a whole. This not only includes the effects of climate change, but all other aspects of global change and human impacts. By interacting with other drivers, climate change can have a number of indirect effects that are sometimes surprising and difficult to predict. For example, climate warming can increase the prevalence of infectious aquatic diseases, which can cause rapid population declines or extinctions (Harvell *et al.* 2002).

Finally, species faced with significant climate change may be able to adapt and show evolutionary responses that may alter their temperature tolerance or other preferences. There is increasing evidence for both short-term acclimatory and long-term adaptive acquisition of climate resistance in some species (Worm and Lotze 2016). However, larger species with slower life histories, such as many commercial fish, are likely to adapt more slowly to changing conditions than fast-growing species (Perry *et al.* 2005). This has important implications for fisheries, as species with slower life histories are already more vulnerable to overexploitation and potentially less able to compensate for climate change effect.

## Impacts on marine fisheries

Climate variability has affected fish and fisheries for most of history. Yet, over past decades, the effect of fisheries exploitation itself has been the major driver for changes in stock abundance and catches, far outweighing the effect of climate variability (Worm *et al.* 2009). Driven by rising human populations and increasing effort and efficiency, global catches have rapidly increased from 1950 to 1990 and stabilized or slightly declined since then, while fishing effort continues to increase (Figure 3a; Pauly and Zeller 2016). Thereby, reconstructed catches including discards, unreported catches, artisanal, subsistence, and recreational fisheries are much higher than those reported officially. The high fishing pressure has led to strong declines in fish biomass in the global ocean, particularly since the 1970s, and today one to two thirds of fished stocks are considered overfished (Figure 3b; Worm *et al.* 2009; Froese *et al.* 2012; Christensen *et al.* 2014; FAO 2016). Yet increased monitoring, assessments and more effective fisheries management and conservation have helped rebuilding stocks in some regions (Worm *et al.* 2009). What will happen to fish and fisheries in the future partly depends on the development of fisheries and their management and partly on changes in climate and other human impacts.

As reviewed above, climate change will alter the distribution, abundance and body size of species important to commercial fisheries. This will affect their spatial and temporal availability and the amount and value of their potential catch. In terms of fished species and places there will be winners and losers, and fisheries will need to adapt to where and when they can fish which species, how much they can catch, and how large and valuable those species are.

There are increasing efforts to project future changes in fish abundance and potential catches using various modelling approaches. The results highly depend on the choice of climate model, the choice of ecosystem model, the spatial and temporal scale and resolution, and the different warming or fisheries scenarios incorporated. Every model is essentially wrong and only an approximation of reality. Yet with more studies becoming available, we gain a better idea of expected trends. Already the climate models can vary substantially in their predictions of warming and primary production (Bopp *et al.* 2013), which in turn influence predictions of fish production and catch. In the following figure, we highlight a few studies that specifically aimed to model changes in fish abundance and potential catch.

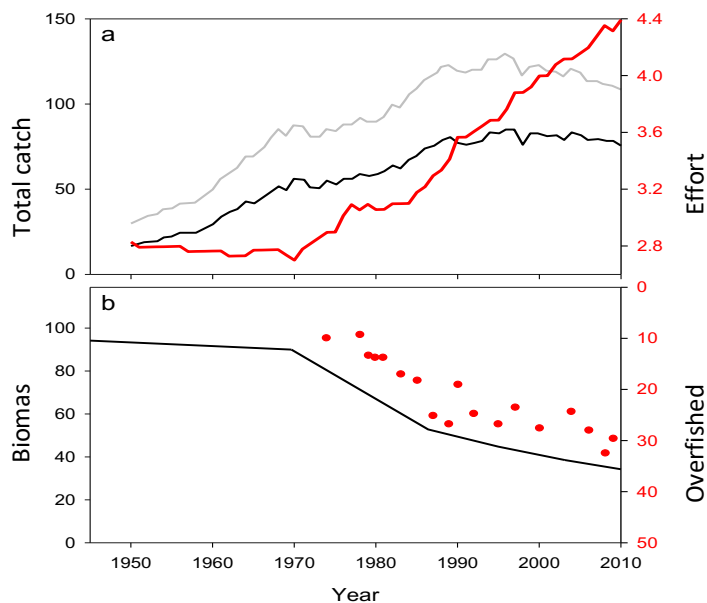

**Figure 3.** Development of global fisheries from 1950-2010: a) officially reported (black line) and reconstructed (gray line) total catch (after Pauly and Zeller 2016) and effort (red line, after Worm and Branch 2012); b) remaining global biomass of predatory fish (black line, after Christensen *et al.* 2014), and percent of overfished stocks (red dots, after FAO 2016).

Based on a species-distribution model, the predicted poleward shift of many species will lead to a large-scale redistribution of global catches, with a 30–70% increase in catch potential in high latitudes and an up to 40% decrease in the tropics under a high-emission scenario (Abb. 4.13-4; Cheung *et al.* 2010).

Stronger declines in catch potential are predicted in the coastal ocean, where most of the actual fisheries catch occurs, and increases in the open ocean if species migrate deeper and further offshore. Maximum body weight is

expected to decrease by 14-24% globally from 2000-2050 due to changes in the distribution and abundance and part to changes in physiology (Abb. 2), with stronger declines in tropical than polar areas (Cheung *et al.* 2013).

Focusing more on coastal and shelf regions, a study using a food-web model based on size structure, not individual species, projects a 30-60% decline in potential fish production by 2050 across some important tropical shelf and upwelling areas compared to a 28-89% increase in some high latitude shelf areas (Blanchard *et al.* 2012). Another study, using a comparable size-structured model but accounting for food-web interactions, also predicts increased fish productivity at high latitudes and decreased productivity at low and mid latitudes, with considerable regional variations (Barange *et al.* 2014). With some exceptions, increases and decreases in fish production by 2050 were estimated to be <10% from present yields. These results are broadly comparable to the above (Cheung *et al.* 2010) albeit based on different approaches. In all cases, the future fish production or catch potential strongly depended on the predicted primary production, which in turn depends on the choice of climate model (Bopp *et al.* 2013). Thus, our predictions are strongly dependent on the quality of both climate and ecosystem models.

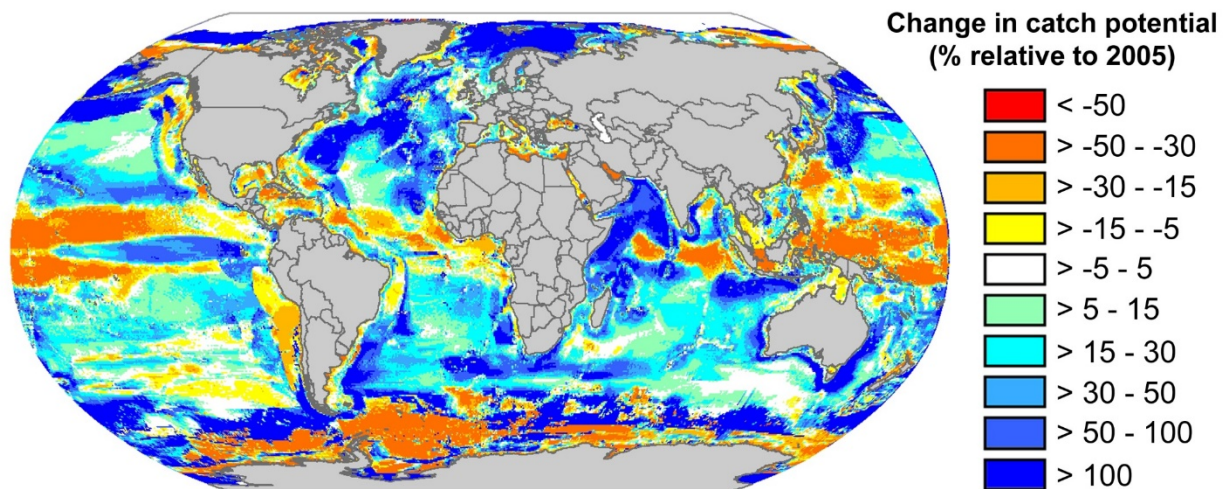

**Figure 4.** Projected changes in maximum catch potential from 2005 to 2050 (10-year average) under climate change scenarios SRES A1B (after Cheung *et al.* 2010).

### Management and governance

The future of fish and fisheries will only in part depend on climate change. Over the past decades, the effect of fisheries themselves was much stronger than the effect of climate on fish biomass and catches, and a lot will depend on the future of fisheries management and ocean governance. If we follow a 'business-as-usual' approach and continue to increase fishing effort, efficiency and destructiveness we will likely see a further decline in global fish biomass and catches. Yet if we follow a path to more sustainable resource use, rebuilding of depleted stocks and conservation of marine biodiversity and ecosystems, we may be able to halt or even reverse the decline (Worm *et al.* 2009). However, similar to regional variation in climate change, there are considerable regional differences in the level of stock assessments and monitoring, management effectiveness, and conservation initiatives across the world's oceans.

Several studies have explored the interactions between different climate change and management scenarios. For example, in the North Atlantic, four contrasting economic scenarios based on fishing fleets and industries were designed to reflect alternative regional management and governance structures until 2040 (Mullon *et al.* 2016). Overall, the level of fisheries regulation was the most important factor for the long-term fisheries development, and the effects of governance and trade decisions were more important than the effects of climate change. However, the predicted poleward shift of many species will have implications for fishing patterns, as well as the interplay between wild fisheries and aquaculture. This study demonstrates the potentially complex interactions between different components of the social-ecological system.

Another study was done in the Baltic Sea, which has already experienced intensive fishing, eutrophication and warming in the 20th century and faces accelerated climate change in the 21st century (Niiranen *et al.* 2013). A multi-model approach exploring the interactions of these multiple human impacts suggests that regional management of fishing intensity and nutrient loading play the most important roles for the future of the Baltic Sea ecosystem.

One important issue in the social-ecological responses to climate change is time lags, with species range shifts moving poleward faster than their respective fisheries (Pinsky and Fogarty 2012). This may allow fish stocks to increase at their northern edge due to lower exploitation while placing too much fishing pressure on declining stocks at their southern edge. Fisheries management would need to adjust fishing mortality spatially for species known to move poleward or offshore. Also, lower-trophic level species and highly exploited stocks may be more affected by climate change because they are highly dependent on new recruitment, which is strongly influenced by temperature and primary production (Britten *et al.* 2016). In most fisheries, fishing pressure is too high and individuals get caught before they reach maturity and are able to reproduce. This effectively truncates the age- and size-structure of stocks (Froese *et al.* 2016) and the fishery then becomes increasingly dependent on new recruitment, which increases the susceptibility of both the stock and fishery to climate change (Brander 2007). Reducing fishing mortality and optimizing the targeted size classes may help rebuilding stocks and mitigate the impacts of climate change.

Currently, there are several global initiatives that will influence the future of fisheries management and ocean governance on a regional and global scale, including the 2030 Agenda for Sustainable Development, the Sustainable Development Goals, and the Paris Agreement of the Conference of the Parties of the United Nations Framework Convention on Climate Change (FAO 2016). The Food and Agriculture Organization's Blue Growth Initiative helps countries to implement the new global agenda and promotes the Code of Conduct for Responsible Fisheries and the Ecosystem Approach to Fisheries and Aquaculture. It particularly assists vulnerable coastal communities where marine ecosystems are already under stress from pollution, habitat degradation, overfishing and harmful practices (FAO 2016). The future of fish and fisheries will strongly depend on the implementation of these initiatives.

### **Biodiversity as insurance**

Marine biodiversity may not only be altered by but also provide resilience against climate change. An increasing number of studies shows that higher genetic, species, and habitat diversity enhance the variety of possible ecological responses and adaptive capacity in the face of climate change (Worm and Lotze 2016). For example, higher genetic and species diversity have been linked to faster recovery of damaged habitats and depleted fish stocks, and higher species richness or fish stock diversity has been linked to higher ecosystem productivity and stability (Worm *et al.* 2006). This is analogous to a 'portfolio effect' in finances and an important insurance against climate-driven fluctuation in marine ecosystems and exploited fish stocks. Maintaining population, species, and habitat diversity is now generally seen of critical importance in stabilizing ecosystem structure, functions and services and protect their capacity to adapt in a variable and changing world (Worm and Lotze 2016).

This has implications for marine conservation planning. Tropical regions are predicted to suffer most from species loss due to climate change and are hotspots of multiple increasing human pressures (Cheung *et al.* 2009, Halpern *et al.* 2015). Yet at the same time, they often lack resources and capacity for mitigation and adaptation and experience low management capacity (McClanahan *et al.* 2008). This combination of multiple and intensifying threats with a low management capacity, yet high reliance on seafood and other ocean services requires a strong conservation focus on tropical areas. On the other hand, polar ecosystems experience rapid climate change, possible extinction of polar specialist and ice-dependent species, and growing pressures from human development (Michel *et al.* 2012), thus also requiring strong conservation action to protect its integrity and functions.

## **REFERENCES**

- Barange, M., Merino, G., Blanchard, J. L., Scholtens, J., Harle, J., Allison, E. H., Allen, J. I., Holt, J. and S. Jennings. 2014. Impacts of climate change on marine ecosystem production in societies dependent on fisheries. *Nat. Clim. Change*, 4: 211–216.

- Blanchard, J. L., Jennings, S., Holmes, R., Harle, J., Merikno, G., Allen, J. I., Holt, J., Dulvy, N. K. and M. Barange. 2012. Potential consequences of climate change for primary production and fish production in large marine ecosystems. *Phil. Trans. B*, 367: 2979–2989.
- Bopp, L., Resplandy, L., Orr, J. C., Doney, S. C., Dunne, J. P., Gehlen, M., Halloran, P., Heinze, C., Ilyina, T., Seferian, R., Tjiputra, J. and M. Vichi. 2013. Multiple stressors of ocean ecosystems in the 21st century: projections with CMIP5 models. *Biogeosciences*, 10: 6225–6245.
- Brander, K. M. 2007. Global fish production and climate change. *PNAS*, 104: 19709–19714.
- Britten, G. L., Dowd, M. and B. Worm. 2016. Changing recruitment capacity in global fish stocks. *PNAS*, 113: 134–139.
- Cheung, W. W. L., Lam, V. W. Y., Sarmiento, J. L., Kearney, K., Watson, R. and D. Pauly. 2009. Projecting global marine biodiversity impacts under climate change scenarios. *Fish Fish*, 10: 235–251.
- Cheung, W. W. L., Lam, V. W. Y., Sarmiento, J. L., Kearney, K., Watson, R., Zeller, D. and D. Pauly. 2010. Large-scale redistribution of maximum fisheries catch potential in the global ocean under climate change. *Glob. Change Biol.*, 16: 24–35.
- Cheung, W. W. L., Sarmiento, J. L., Dunne, J., Froehlicher, T. L., Lam, V. W. Y., Palomares, M. L. D., Watson, R. and D. Pauly. 2013. Shrinking of fishes exacerbates impacts of global ocean changes on marine ecosystems. *Nat. Clim. Change*, 3: 254–258.
- Christensen, V., Coll, M., Piroddi, C., Steenbeek, J., Buszowski, J. and D. Pauly. 2014. A century of fish biomass decline in the ocean. *Mar. Ecol. Progr. Ser.*, 512: 155–166.
- FAO. 2016. *The state of world fisheries and aquaculture 2016*. Food and Agriculture Organization, Rome.
- Froese, R., Winker, H., Gascuel, D., Sumaila, U.R. and Pauly, D. 2016. Minimizing the impact of fishing. *Fish Fish*, 17(3): 785–802.
- Froese, R., Zeller, D., Kleisner, K. and D. Pauly. 2012. What catch data can tell us about the status of global fisheries. *Mar. Biol.*, 159: 1283–1292.
- Halpern, B. S., Frazier, M., Potapenko, J., Casey, K. S., Koenig, K., Longo, C., Lowndes, J. S., Rockwood, R. C., Selig, E. R., Selkoe, K. A. and S. Walbridge. 2015. Spatial and temporal changes in cumulative human impacts on the world's ocean. *Nat. Comm.*, 6: 7615.
- Harley, C. D. G., Hughes, A. R., Hultgren, K. M., Miner, B. G., Sorte, C. J. B., Thornber, C. S., Rodriguez, L. F., Tomanek, L. and S. L. Williams. 2006. The impacts of climate change in coastal marine systems. *Ecol. Lett.*, 9: 228–241.
- Harnik, P. G., Lotze, H. K., Anderson, S. C., Finkel, Z. V., Finnegan, S., Lindberg, D. R., Liow, L. H., Lockwood, R., McClain, C. R., McGuire, J. L., O'Dea, A., Pandolfi, J. M., Simpson, C. and D. P. Tittensor. 2012. Extinctions in ancient and modern seas. *Trends Ecol. Evol.*, 27: 608–617.
- Harvell, C. D., Mitchell, C. E., Ward, J. R., Altizer, S., Dobson, A. P., Ostfeld, R. S. and M. D. Samuel. 2002. Climate warming and disease risks for terrestrial and marine biota. *Science*, 296: 2158–2162.
- Lotze, H. K., Lenihan, H. S., Bourque, B. J., Bradbury, R. H., Cooke, R. G., Kay, M. C., Kidwell, S. M., Kirby, M. X., Peterson, C. H. and J. B. C. Jackson. 2006. Depletion, degradation, and recovery potential of estuaries and coastal seas. *Science*, 312: 1806–1809.
- Mcclanahan, T. R., Cinner, J. E., Maina, J., Graham, N. A. J., Daw, T. M., Stead, S. M., Wamukota, A., Brown, K., Ateweberhan, M., Venus, V. and N. V. C. Polunin. 2008. Conservation action in a changing climate. *Conserv. Lett.*, 1: 53–59.
- Michel, C., Bluhm, B., Gallucci, V., Gaston, A. J., Gordillo, F. J. L., Gradinger, R., Hopcroft, R., Jensen, N., Mustonen, T., Niemi, A. and T. G. Nielsen. 2012. Biodiversity of Arctic marine ecosystems and responses to climate change. *Biodiversity*, 13: 200–214.
- Mullon, C., Steinmetz, F., Merino, G., Fernandes, J. A., Cheung, W. W. L., Butenschoen, M. and M. Barange. 2016. Quantitative pathways for Northeast Atlantic fisheries based on climate, ecological-economic and governance modelling scenarios. *Ecol. Model.*, 320: 273–291.
- Niiranen, S., Yletyinen, J., Tomczak, M. T., Blenckner, T., Hjerne, O., Mackenzie, B. R., Mueller-Karulis, B., Neumann, T. and Meier, H. E. M. 2013. Combined effects of global climate change and regional ecosystem drivers on an exploited marine food web. *Glob. Change Biol.*, 19: 3327–3342.
- Pauly, D. and D. Zeller (2016) Catch reconstructions reveal that global marine fisheries catches are higher than reported and declining. *Nature Communications*, 7: 10244.
- Perry, A. L., Low, P. J., Ellis, J. R. and J. D. Reynolds. 2005. Climate change and distribution shifts in marine fishes. *Science*, 308: 1912–1915.

- Pinsky, M. L. and M. J. Fogarty. 2012. Lagged social-ecological responses to climate and range shifts in fisheries. *Clim. Change*, 115: 883-891.
- Pinsky, M. L., Worm, B., Fogarty, M. J., Sarmiento, J. L. and S. A. Levin. 2013. Marine taxa track local climate velocities. *Science*, 341: 1239-1242.
- Sheridan, J. A. and D. Bickford. 2011. Shrinking body size as an ecological response to climate change. *Nat. Clim. Change*, 1: 401-406.
- Worm, B., Barbier, E. B., Beaumont, N., Duffy, J. E., Folke, C., Halpern, B. S., Jackson, J. B. C., Lotze, H. K., Micheli, F., Palumbi, S. R., Sala, E., Selkoe, K. A., Stachowicz, J. J. and R. Watson. 2006. Impacts of biodiversity loss on ocean ecosystem services. *Science*, 314: 787-790.
- Worm, B., Hilborn, R., Baum, J. K., Branch, T. A., Collie, J. S., Costello, C., Fogarty, M. J., Fulton, E. A., Hutchings, J. A., Jennings, S., Jensen, O. P., Lotze, H. K., Mace, P. M., McClanahan, T. R., Minto, C., Palumbi, S. R., Parma, A. M., Ricard, D., Rosenberg, A. A., Watson, R. and D. Zeller. 2009. Rebuilding global fisheries. *Science*, 325: 578-585.
- Worm, B. and T. Branch. 2012. The future of fish. *Trends Ecol. Evol.*, 27, 594-599.
- Worm, B. and H. K. Lotze. 2016. Marine biodiversity and climate change. In Letcher, T. (ed) *Climate and global change: observed impacts on Planet Earth*, Elsevier, Amsterdam.



## A TRIBUTE TO WALTER ARNDT (1891-1944)\*

Daniel Pauly

*Sea Around Us, Institute for the Oceans and Fisheries, 2202 Main Mall, University of British Columbia, Vancouver, Canada*  
[d.pauly@oceans.ubc.ca](mailto:d.pauly@oceans.ubc.ca)

### Abstract

Walter Arndt was a German zoologist who was killed by the Nazis in 1944. As a 16-year-old, he published a short paper on the annual food consumption of a young pike (W. Arndt, *Natur und Haus*, 1907, 15:191). This paper is here translated from German and completed, so that its main result, a ration estimate for *Esox Lucius*, can be entered in FishBase ([www.fishbase.org](http://www.fishbase.org)).

### Introduction

The German zoologist Walter Arndt was born in 1891 in Landeshut, Silesia, an eastern part of Germany that now belongs to Poland. He was murdered by the Nazis in 1944 (see Wikipedia).

Recently, while reading *The Art of Naming* (Ohl 2018), I learned that Walter Arndt, at the age of 16, he published a short account on the food consumption of pike (*Esox lucius*) in German, reproduced here as Figure 1. Below is my translation of this account.

**Jährliche Nahrungsmenge eines Hechtes im Aquarium.**

Ende Juli 1905 fing ich in einem nahen Teiche einen etwa 16 cm langen Hecht. Derselbe wurde in einem ungefähr 12 l Wasser haltenden Aquarium untergebracht, das mit *Elodea canadensis* bepflanzt war. Schon nach einigen Tagen nahm der Hecht willig kleine Fische an. Um ein Bild der Nahrungsmenge des Hechtes zu haben, notierte ich vom 1. Januar 1906 bis zum 1. Januar 1907 alles ihm gereichte Futter. Nach diesen Notierungen fraß der Hecht in der genannten Zeit folgendes:

169 Regenwürmer,	durchschnittlich	8	cm	lang
28 Mehlwürmer	"	2	"	"
52 Kaulquappen	"	1 1/2	"	"
17 Moderlieschen	"	2	"	"
47 Ellritzen	"	2 1/2	"	"
1 Goldfisch	"	5 1/2	"	"

Das Gesamtgewicht der Regenwürmer betrug etwa 50 g, der Mehlwürmer 8 g, der Kaulquappen 12 g, der Fische zusammen 32 g. Das Gewicht aller 314 Futtertiere beträgt mithin 102 g.

W. Arndt.

### Annual food consumption of a pike in an aquarium

"Near the end of 1905, I caught in a neighboring pond a pike of about 16 cm. This was put in an aquarium with approximately 12 liters of water, and which also contained *Elodea canadensis*. After only a few days, the pike took small fish willingly. To obtain a picture of the food consumption of pike, I recorded all the food given to it from 1 January 1906 to 1 January 1907. According to these notes, the pike in that time, consumed the following:

\* Cite as Pauly, D (2018) "A Tribute to Walter Arndt (1891-1944)," Pp. 14-15 In Pauly D. and V. Ruiz-Leotaud (eds.) Marine and Freshwater Miscellanea. Fisheries Centre Research Reports 26(2). Institute for the Oceans and Fisheries, University of British Columbia.

Food type	Number	Mean length (cm)
Earthworms	169	8
Meal worms	28	2
Tadpoles	52	1 1/2
Belica	17	2
Eurasian minnow	47	2 1/2
Goldfish	1	5 1/2

The total weight of the earthworms was about 50 g, of the mealworms 8 g, the tadpoles 12 g; of the fish taken together 32 g. The total weight of all food items was thus 102 g.”

### Comments

Przybylki (1996) published the following parameter estimates of the von Bertalanffy growth formula (VBGF) for pike in the Upper Warta River, in the heart of what was then Silesia:  $L_{\infty} = 54.3$  cm total length;  $K = 0.25$  year<sup>-1</sup>. The VBGF is thus

$$L_t = 53.4 (1 - e^{-0.25(t+t_0)})$$

Given that  $t_0$  is not known, we cannot infer the absolute age of the 16 cm pike, which would be predicted by inverting the VBGF. However, however, we can infer that this unknown age, plus one year, would yield a size of 24.5 cm.

An average length-weight relationship is provided by FishBase ([www.fishbase.org](http://www.fishbase.org)) for pike, which has the form  $W = 0.00447 \cdot L^{3.08}$ , where  $W$  is in g and  $L$  (total) length is in cm. Hence, the weights at 16 and 24.5 cm would be 22.9 and 84.9 g respectively, for a one-year growth increment of 62 g.

If the fish that young Walter Arndt grew as suggested here, its gross food conversion efficiency would have been  $62 / 102 \approx 0.61$ , which is rather high, but not impossibly so for a placid small fish.

Finally, we estimate its daily ration by relating the daily food consumption of the pike ( $102 \text{ g} / 365 \text{ days} = 0.28 \text{ g} \cdot \text{day}^{-1}$ ) to its geometric mean weight during the year of observation, i.e., 44.1 g. Thus, the daily ration of this pike was 0.63 % of its body weight per day, or 2.3 per year, which compares well with other estimates (see Palomares and Pauly 1998).

This is as far as I could go with Arndt's data. His ration estimate for pike will be entered in FishBase ([www.fishbase.org](http://www.fishbase.org)) and will live on.

### ACKNOWLEDGEMENTS

I thank Michael Ohl, of the Museum für Naturkunde, Berlin, for arranging for me to receive a PDF of Walter Arndt's juvenilia.

### REFERENCES

- Arndt, W. 1907. Jährliche Nahrungsmenge eines Hechtes in Aquarium. *Natur und Haus* 15:191.  
 Oh, M. 2018. The Art of Naming. MIT Press, Cambridge, MA. 294 p.  
 Palomares, M.L.D. and D. Pauly. 1998. Predicting food consumption of fish populations as functions of mortality, food type, morphometrics, temperature and salinity. *Marine and Freshwater Research* 49: 447-453.  
 Przybylki, M. 1996. Variation in fish growth characteristics along a river course. *Hydrobiologia* 325: 39-46.



# ELECTROPHORETIC STUDIES OF PERUVIAN ANCHOVETA *ENGRAULIS RINGENS* CONFIRM THE EXISTENCE OF DISTINCT NORTH/CENTRAL AND SOUTHERN STOCKS\*

Jaime Mendo

Universidad Agraria La Molina, Avenida La Molina, Lima, Peru  
[jmendo@lamolina.edu.pe](mailto:jmendo@lamolina.edu.pe)

## Abstract

This contribution is the belated account of a 1990 electrophoretic study of the Peruvian anchoveta *Engraulis ringens*. This fish, endemic to the Humboldt Current upwelling ecosystem, is, in Peru, conventionally divided in a northern/central stock, here represented by samples taken off the cities of Chimbote and Callao, and a southern stock, represented by a sample from Ilo. This study, which was based on 8 polymorphic loci, confirmed that the Chimbote and Callao samples were far more closely related than the samples from Ilo, thus upholding the commonly accepted stock distinctions for this species.

## INTRODUCTION

The Peruvian anchoveta *Engraulis ringens* supports the largest fishery of the world. However, its population structure has been studied very superficially. In particular, the existence of a northern/central stock fully confined to the Peruvian Exclusive Economic Zone (EEZ) and distinct from a Southern stock reaching deeply into the Chilean EEZ has not been investigated as much as may be expected, given its importance for the management of a resource of global importance. Therefore, an electrophoretic study on this topic, performed as part of the author's doctoral thesis work (Mendo 1991), is presented here, although it is somewhat dated.

Following the success of evolutionary studies in human beings and domestic livestock (Cushing 1964), the first studies on the genetic identification of fish stocks were conducted using techniques based on blood groups. However, these techniques require serological expertise for handling fish blood cells and are very labor-intensive (Smith *et al.* 1990).

The identification of units of inheritance by Gregor Mendel (1866), later called 'genes,' and the discovery of the structure of the DNA molecule by Watson and Crick (1953) as the fundamental component of genes, and whose sequence has a direct relationship to the structure of proteins, led to the development of electrophoretic methods, which permit rapid and reliable identification of protein variants reflecting generic differences (Utter *et al.* 1987; Allendorf *et al.* 1987).

Most proteins studied by electrophoresis are enzymes, and thus can be stained to show the activity of specific enzymes. Market and Moller (1959) introduced the concept of isozymes, different forms of a protein with the same enzymatic specificity. Population genetics developed rapidly by adopting the isozyme technology and developed the new concept of allozymes as protein variants produced by allelic forms of the same locus (Prakash *et al.* 1969). The molecular variations obtained through electrophoresis are largely genetically controlled and little affected by environmental disturbances (McAndrew and Majumdar 1983).

Among several molecular methods applied for estimating the level of genetic divergence, gel electrophoresis has been considered the best method for comparing races, species and closely related genera (Bush and Kitto 1978). This technique, which uses the migration of proteins in an electric field to detect small differences in their charge and shape, has frequently been used for stock identification (Allendorf and Utter 1979; Winans 1980; Shaklee 1983; Ferguson and Mason 1981; Ryman 1983; Grant *et al.* 1987 a, 1987b; Hedgecock *et al.* 1988; Vrooman *et al.* 1981; Grant 1985; and see Smith *et al.* 1990 for review). Electrophoretic techniques have been described by many

---

\* Cite as Mendo, J. (2018) Electrophoretic studies of Peruvian anchoveta *Engraulis ringens* confirm the existence of distinct North/Central and Southern Stocks. Pp. 16-26. In Pauly D. and V. Ruiz-Leotaud (eds.) Marine and Freshwater Miscellanea. Fisheries Centre Research Reports 26(2). Institute for the Oceans and Fisheries, University of British Columbia.

authors (e.g., Gordon 1980; Sargent and George 1975; Harris and Hopkinson 1976; Ferguson 1980; Smith 1976; Richardson *et al.* 1986).

Stock identification of anchovies using gel electrophoresis has been carried out for *Engraulis capensis* by Grant (1985), who determined that Namibia and South Africa shared the same stocks; for *Engraulis encrasicolus* by Spanakis *et al.* (1989), who identified distinct stocks occurred in the Aegean and Ionian Seas, by Vrooman *et al.* (1981), who identified three distinct populations of northern anchovy *Engraulis mordax* between southern Baja California and Newport, Oregon, and by Hedgecock *et al.* (1989), who detected substantial genetic variation within and between northern anchovy populations. Also, Daly and Richardson (1980) demonstrated a genetic differentiation between geographically isolated populations of the anchovies *Stolephorus heterolobus* and *S. devisi* from Papua New Guinean waters, now renamed *Encrasicolina heteroloba* and *E. devisi* (see [www.fishbase.org](http://www.fishbase.org)).

Based on phenotypic characters, the Peruvian anchoveta, *Engraulis ringens*, has been considered to consist of two stocks, one off northern/central Peru and another off southern Peru and northern Chile (Serra *et al.* 1979; Jordan 1971; 1974; Tsukayama 1966). However, the hypothesis about the existence of genetically distinct stock units based on the presence of isolated “density centra” during spawning (Pauly and Tsukayama 1987a; Mathisen 1989), has not been tested using electrophoresis.

Thus, this study is to determine the genetic identity of anchoveta stocks off the Peruvian coast by detecting genetic markers (enzymes) using protein electrophoresis. For the analysis, it had to be assumed that electrophoretic variants are neutral or nearly neutral to natural selection and that the geographic distributions of allozymes reflect random genetic drift and migration (Lewontin 1974).

## Material and Method

The methods of sample preparation, vertical electrophoresis (polyacrylamide) and histochemical enzyme staining were taken from Smith (1976), Richardson *et al.* (1986) and Gordon (1980). Here, the electrophoretic procedure basically consisted of three steps:

1. Extraction of enzymes from muscle tissue;
2. Vertical electrophoresis of samples on polyacrylamide gel; and
3. Staining of the gel for each enzyme.

### Sample collection

Anchoveta specimens were collected off northern Chimbote (08°15' S, representing the northern component of the northern/central stock of Peruvian anchoveta), Callao (11°46' S, representing the southern component of the northern/central stock), and Ilo (17°50' S, representing the southern stock) during an IMARPE survey in late June and July 1991. Each sample consisted of 60 individuals, immediately taken out of the catch, introduced into a plastic bag, frozen and held at -25°C until laboratory analysis.

### Preparation of samples for electrophoresis

The muscle tissue (1 g) was extracted from the lateral caudal part of the fish and homogenized with 2 ml buffer (0.1 M Tris-HCl pH 8.0 and B-mercaptoethanol) using a hand-held ground-glass pestle. The extracts were centrifuged at 6000 rpm for 12 minutes, the supernatant was removed from the homogenate, put into Eppendorf tubes of 1.5 ml and finally frozen at -25°C until later analysis.

### Electrophoretic analysis

Vertical polyacrylamide gel electrophoresis was performed in two gel molds, one made by Hoefer Scientifics and another designed by staff of the Laboratory of Genetics of the Universidad Nacional Agraria La Molina in Lima, Peru. A discontinuous electrophoretic system was employed, one using ‘stacking gel’ with relatively large pore size, the other using ‘separation gel’ for separating proteins.

The stacking gel was obtained using Tris-HCl 0.5 M pH 6.8 and a stock solution of acrylamide 4% and bis-acrylamide 2.7% with glycerol 20%. Ammonium persulfate (10%) and Temed (0.004%) were used for the

activation of polymerization. Before running, the samples (20-40  $\mu$ l supernatant, depending on the enzyme) were mixed with sucrose 40% for increasing density and bromophenol blue 0.003% as running marker.

The separation gel was prepared at 6 and 8% strength (weight/volume), depending on the enzyme, using a solution buffer Tris-HCl 1.5 M pH 8.8 and a stock solution of acrylamide at 30% and bis-acrylamide at 0.8% (Sigma). Polymerization was activated using Temed 0.025% and ammonium persulfate (70  $\mu$ l for 10 ml of gel solution). The electrode or tank buffer was Tris (0.02 M) - Glycine (0.192 M) solution pH 8.3. Gels were mostly 180 mm x 150 mm x 1.5 mm and run at 4°C in a refrigerator with stabilized power obtained using a regulated high voltage power supply Bio-Rad Model 200/2.0. The voltage used was varied to get the best results for each enzyme analyzed. Cooling was ensured by keeping the current below 35 mA during a running time of 4 to 6 hours.

### Staining procedures

Staining tests carried out for 7 isozymes revealed best results for esterase (EST), malic enzyme (ME), lactate dehydrogenase (LDH), and malate dehydrogenase (MDH). The isozymes alcohol dehydrogenases adenylate kinase and adenosine deaminase did not exhibit good resolution or activity.

Before staining EST isozymes, the gel was collocated into a Phosphate buffer solution 0.3 M pH 7 for 15-20 minutes. The stain solution was obtained mixing two solutions, one based on 30 mg of a-naphthyl acetate dissolved in 3 ml acetone, and another based on 200 mg fast blue RR salt dissolved in 7 ml of distilled water. Staining solution was poured over the gel in a plastic box incubated at room temperature for 30 - 45 minutes.

The LDH isozymes are visualized by the deposition of a blue formazan dye in the regions of LDH activity. The stain formula contained: 5 ml D, L-lactate of Na 1 M pH 7 (6.07 g NaCO<sub>3</sub>.H<sub>2</sub>O in 50 ml distilled water, 10.6 ml D, L-lactate 85% and distilled water up to 100 ml), 10 ml of Tris-HCl buffer 1 M pH 8, 5 ml lithium lactate 1 M pH 7, 15 mg methyl thiazolyl blue (MTT), 1 mg phenazine methosulphate (PMS), 25 mg nicotinamide adenine dinucleotide (NAD) and 35 ml distilled water. Staining occurred at 37°C in the dark after 10 minutes.

The stain solution for MDH contained: 5 ml L-malate of Na 1M pH 7 (12.5 g Na<sub>2</sub>CO<sub>3</sub>.H<sub>2</sub>O in 50 ml distilled water, 13.4 malic acid and distilled water up to 100 ml), 10 ml of Tris-HCl buffer 1 M pH 8, 15 mg MTT 1 mg PMS, 25 mg NAD and 35 ml distilled water. After 15-20 minutes of incubation at 37°C in the dark, bands appeared. Gel for ME staining must contain 20 mg nicotinamide adenine dinucleotide phosphate. The stain solution for ME contained: 5 ml L-malate of Na 1M pH 7 (12.5 g Na<sub>2</sub>CO<sub>3</sub> H<sub>2</sub>O in 50 ml distilled water, 13.4 malic acid and distilled water up to 100 ml), 10 ml of Tris-HCl buffer 1 M pH 8, 15 mg MIT, 1 mg PMS, 25 mg NAD and 35 ml distilled water. Staining solution was poured over the gel in a plastic box incubated at 35°C in the dark for 10 minutes.

After the bands appeared, each gel was preserved with a solution of methanol (120 ml), acetic acid (20 ml) and 280 ml of distilled water.

### Data processing

The procedures, used to compare allelic and genotypic data obtained through electrophoresis for the anchoveta from different localities, were based on Chakraborty and Leimar (1987), and Utter *et al.* (1987).

The analysis consisted basically on the interpretation of electromorphs on gels (allelic and genetic variation), the computation of allele frequencies at each locus and the conversion of allelic frequency data into a measure of genetic distance among samples as reported by Buth (1984). The numbers of loci for each protein are described according to their mobility, i.e., the locus with the least anodal migration is designed one, the next two and so on. Allelic variants were designated in terms of their mobility and the common allele is designated 100. Other alleles were given numbers that indicate the mobility of their products relative to that of the common allele. Catodal migration of allele variants was not registered.

The individual genotypes expressed for each locus in each population were tabulated to obtain the genotype frequencies and therefore the allele frequencies which are a very important characteristic of a sample (Utter *et al.* 1987). Genetic variability was measured by directly counting the number of heterozygotes over all loci analyzed and indirectly by testing the deviation of allele frequencies from the expected Hardy-Weinberg proportion for each locus using a Chi-squared test for goodness of fit. Also, the proportion of polymorphic loci and the average

number of alleles per locus were calculated. Differences of genotypic and allelic frequencies among samples were tested by a Chi-square test using a contingency table based on the total number of alleles observed in the samples.

The amount of genetic difference among samples was determined using Nei's genetic distance (D; Nei 1978), as commonly used by several authors (Allendorf and Utter 1979; Stahl 1987; Grant *et al.* 1987a, 1987b; Hedgecock *et al.* 1988; Grant 1985). Nei's genetic distance has a biological meaning, i.e., it can be seen, under certain assumption, as the average proportion of nucleotide substitutions that have occurred since two groups diverged. It is defined as  $D = -\ln(I)$ , where for a single locus:

$$I = \sum x_i y_i / \sqrt{\sum x_i^2 \sum y_i^2}$$

where  $I$  is a genetic entity, and  $x_i$  and  $y_i$  are the frequencies of specific alleles in populations  $X$  and  $Y$ , respectively. The matrix of genetic distances for the different samples was used to carry out a cluster analysis on the paired values using the unweighted pair-group method (Sneath and Sokal 1973).

## Results and Discussion

### Interpretation of banding variations

Table 1 shows the proteins with specific differences either in mobility or allele frequencies. A total of 8 gene loci were detected encoding the 4 proteins examined to characterize polymorphisms for subsequent population screening. Electrophoretic variants were observed at 3 loci. Variations at these loci were rare, however. A brief characterization of each polymorphic system follows:

#### *Esterase (EST)*

Esterase is coded for by several loci; only the first (EST-I) was located near the origin and behaved as do monomers in other vertebrates (Cruz *et al.* 1982; McAndrew and Majumdar 1983). Homozygotes are single-banded and heterozygotes double-banded. A second, more mobile zone of activity was observed which contained up to 6 bands and whose electrophoretic behavior was difficult to interpret.

Two zones with different mobility have also been reported for the Northern anchovy (*Engraulis mordax*) by Hedgecock *et al.* (1989), for Atlantic herring (*Clupea harengus*) by Kornfield *et al.* (1982) and for some species of tilapia (Family Cichlidae) by McAndrew and Majumdar (1983) and Cruz *et al.* (1982).

#### *Lactate dehydrogenase (LDH)*

Three loci were observed and scored in all samples. The loci corresponded to those also found in many vertebrates (Witt 1970). They exhibited particularly high activity and the stained gels could easily be interpreted within 15 minutes of applying the stain. The two slower bands are probably the homotetrameric expression of WH-1 and WH-2 loci and the faster band represent the WH-3 locus. The presence of three bands of LDH has been reported for the Cape anchovy (*Engraulis capensis*) by Grant (1985). However, these three bands were presented as the homotetrameric products of LDH-1 (least anodic) and LDH-2 (most anodic), and an intermediate heterotetrameric band as an isozyme with two subunits from each locus. These subunits were not observed in the Peruvian anchoveta and therefore the three bands were considered to represent three loci.

Hedgecock *et al.* (1989) also report the presence of two loci encoding LDH for the Northern anchovy. Staining of LDH in samples from the southern region (Ilo) sample revealed a higher activity of band three (LDH-3), relative to the two other bands, than in samples from the North and Central regions (Chimbote and Callao, respectively).

#### *Malate dehydrogenase (MDH)*

The products of three loci were detected. The more-anodic band near the origin MDH-1 did not occur in all samples, i.e., it appeared only in samples from the central and southern regions. It represents most likely a mitochondrial enzyme (Grant 1985). The three more-anodic bands in the common phenotypes were interpreted as the products of two loci. Homodimeric bands appeared for each locus as also reported by Grant (1985) for *E. capensis*.

The Peruvian and the Cape anchovy gene expressions for MDH differ from that for herring (*Clupea harengus*), in which the most anodic bands represented a duplicated locus (Anderson *et al.* 1981).

### Malic enzyme (ME)

As for MDH and LDH, malic enzyme exhibited high activity and the stained gels could be interpreted after 15 minutes of applying the stain. Two presumed anodal loci near the origin were observed. The Mendelian nature of inheritance has been established for ME-2 with two banded heterozygotes. This second locus is also expressed in clupeid fishes (Kornfield *et al.* 1982); however, it was not observed in Cape anchovy (Grant 1985).

Locus	Sample sizes/alleles	Sample		
		Chimbote	Callao	Ilo
EST-1	N	56	60	58
	80	0.263	0.189	0.121
	100	0.737	0.811	0.879
LDH-1	N	60	60	60
	100	1.000	1.000	1.000
LDH-2	N	60	60	60
	100	1.000	1.000	1.000
LDH-3	N	60	60	60
	100	0.520	0.438	0.400
	106	0.120	0.136	0.128
	112	0.120	0.136	0.128
	118	0.120	0.136	0.128
MDH-2	N	60	60	60
	100	1.000	1.000	1.000
	100	1.000	1.000	1.000
MDH-3	N	60	50	60
	100	1.000	1.000	1.000
ME-1	N	50	60	60
	100	1.000	1.000	1.000
ME-2	N	50	60	40
	100	0.560	0.425	0.167
	120	0.440	0.575	0.833

### Genetic variation within samples

Electrophoretic variation was detected in the anchoveta proteins examined (*EST-1*, *WH-3* and *ME-2*). The analysis of the protein phenotypes suggests high levels of individual genetic variation as shown in Table 2. The average number of allele per locus and per sample is 1.75. The average number of alleles was the same in all samples and is very close to the average number observed for *Engraulis mordax* by Hedgecock *et al.* (1989). The proportion of polymorphic loci is the same for samples from the northern, central and southern regions (38 %) and is higher than those reported for *E. mordax* (33%) and *E. capensis* (32%).

Item		Chimbote	Callao	Ilo	Mean (SE)
Mean sample size per locus (SE)	--	57.0 (1.60)	57.5 (1.64)	57.3 (2.50)	57.3 (0.10)
Average number of alleles per locus (SE)	--	1.75 (0.62)	1.75 (0.62)	1.75 (0.62)	1.75 --
Proportion of loci polymorphic (%)	--	38.0	38.0	38.0	38.0
Average heterozygosity per locus (%)	Observed (SE)	12.7 (6.3)	13.1 (6.6)	8.2 (4.3)	11.3 (1.6)
	Expected (SE)	13.6 (7.2)	14.45 (7.3)	11.0 (5.6)	12.9 (1.0)

Average observed heterozygosities were estimated as 12.7% and 13.1% in samples from the northern and central regions, respectively and 8.2% in sample from the southern region. The high heterozygosity observed in samples from the northern and central regions was due to the high values obtained at the *ME-2* loci (40.0 and 45.0 % respectively), as illustrated in Table 3. The lowest value of heterozygosity was detected in the sample from the south (13.8%) at *EST-1*. A deficiency of heterozygotes was detected at all polymorphic loci, except for the sample from the North, at the *WH-3* locus.

Table 3. Genotype frequencies and heterozygosity (H, in %) per locus obtained from electrophoretic patterns for the Peruvian anchoveta. Expected proportions from genotype frequencies and heterozygosity under binomial expansion (Hardy-Weinberg equilibrium) are given in brackets.

Locus	Genotype	Chimbote	Callao	Ilo
EST-1	AA	0 (3.9)	0 (2.1)	0 (0.9)
	AA'	20 (21.7)	18 (18.4)	8 (12.3)
	A'A'	36 (30.4)	42(39.5)	50 (44.8)
	H	35.7 (38.8)	30.0 (30.7)	13.8 (21.2)
LDH-1	AA	60	60	60
	H	0 (0)	0 (0)	0 (0)
LDH-2	BB	60	60	60
	H	0 (0)	0 (0)	0 (0)
LDH-3	CC	35 (25.5)	43 (35.5)	39 (32.1)
	CC'	15 (10.2)	18 (21.3)	21 (23.5)
	C'C'	0 (4.1)	0 (3.2)	0 (4.3)
	H	26.0 (20.4)	30.0 (35.5)	31.7 (39.0)
MDH-2	BB	60	50	60
	H	0 (0)	0 (0)	0 (0)
MDH-3	CC	60	50	60
	H	0 (0)	0 (0)	0 (0)
ME-1	AA	50	60	60
	H	0 (0)	0 (0)	0 (0)
ME-2	BB	8 (15.7)	10 (10.8)	0 (1.1)
	BB'	20 (24.6)	27 (29.4)	8 (11.1)
	B'B'	22 (9.7)	23 (19.8)	32 (27.8)
	H	40.0 (49.2)	45.0 (49.0)	20.0 (27.8)

Average heterozygosity (H) values obtained for the Peruvian anchoveta are slightly higher than those estimated for other anchovies (Table 4). Grant (1985) reported for *E. capensis* a H value of 11.0 to 12.8%; Fujio and Kato (1979) found a value of 6.7% for *E. japonicus* and Daly and Richardson (1980) found H to be 10.1% and 6.8% in two anchovies of the genus *Engrasicholina*.

Smith and Fujio (1982), analyzing H from marine fishes, suggest that enzyme structure is more influential than function, with monomeric enzymes more variable than dimeric, which, in turn, are more variable than tetrameric enzymes. This may have influenced the H values in the Peruvian anchovy. However, in this study, enzymes with high variability as EST and less variable enzymes as LDH and MDH, were analyzed. Soulé (1976) suggests that heterozygosity may be related to population size, with larger populations having higher heterozygosity. While there is, in general, little support for this in the literature (but see Smith and Fujio 1982), the actual finding of lower heterozygosity in the southern anchoveta population would be in line with that hypothesis, considering the lower abundance in the south.



Species	No. of pops studied	No. of loci studied	Mean no. alleles per locus	Polymorphic loci	Mean heterozygosity Obs. (%)	Exp.	Source <sup>2</sup>
<i>Engraulis japonicus</i>	1	29	-	36.4	6.7	-	1
<i>capensis</i>	31	31	-	48.3	-	11.5	2
<i>mordax</i>	9	39	1.6	39.8	7.7	7.5	3
<i>ringens</i>	3	9	1.8	38.0	11.3	12.9	this study
<i>Encrasicholina heteroloba</i>	3	18	1.7	22.2	-	-	4
<i>devisi</i>	3	19	1.7	17.1	-	-	4

Extracted from Table 8 in Hedgecock *et al.* (1989).

(1) Fujio & Kato (1979); (2) Grant (1985); (3) Hedgecock *et al.* (1980); (4) Daly & Richardson (1980).

### Hardy-Weinberg ratios

As can be seen in Table 1, from 8 enzyme-coding loci identified, 3 loci, *EST-1*, *LDH-3* and *ME-2*, showed high frequencies of variable phenotypes. The Hardy-Weinberg ratios expected with random mating and in the absence of migration and mutation and natural allele selection were tested for the three polymorphic loci. With a single exception (*ME-2*; Chimbote sample), none of the samples show significant departures from Hardy-Weinberg expectations (Table 5), which suggests that random mating occurs.

Locus	Chimbote	Callao	Ilo
EST-1	4.64 (0.994)	2.05 (0.359)	2.06 (0.356)
LDH-3	0.01 (0.994)	3.69 (0.158)	1.72 (0.421)
ME-2	7.53 (0.021)	0.33 (0.849)	1.74 (0.149)

### Genetic variation between samples

Significant differences of allelic frequencies among samples were detected for *EST-1* ( $X^2 = 6.37$ ;  $P < 0.05$ ) and *ME-2* ( $X^2 = 33.2$ ;  $P < 0.01$ ), which indicates that allelic frequencies are dependent of locality.

Nei's genetic identity ( $I$ ) and distance ( $D$ ) statistic for all loci examined average 0.982 (sd = 0.0136) and 0.0184 (= 0.0139) respectively. These values are higher than those observed for other anchovy species. Grant (1985) detected an average genetic distance of 0.0003 between Namibian and South African anchovy populations which represents a very small value compared to genetic distances between conspecific populations in other fishes (Shaklee *et al.* 1982). Small values of genetic distance were also reported for *E. mordax* ( $D = 0.008$ ). In the first case, Grant (1985) showed no geographic trends in the genetic distance between populations (as observed in the Peruvian anchoveta), while in the other case, the allele frequencies showed a significant dependence of locality at five of 11 polymorphic loci.

A dendrogram illustrating the inferred genetic relationships in anchoveta samples from the northern (Chimbote), central (Callao) and southern (Ilo) regions is shown in Figure 1. The traditional hypothesis about the existence of two genetically distinct stocks (northern/central and southern) along the Peruvian coast (Jordan 1974; Tsukayama 1966; IMARPE 1970; Pauly and Tsukayama 1987) is supported by these findings.

However, it must be noted that the existence of more or less geographically isolated populations (as shown by means of tagging experiments; Mendo 1991), does not necessarily imply a completely restricted gene flow between the populations. For future studies, it would be desirable to gain more insight into the variability within geographical regions, and into possible effects of age and sex. Thus, it is possible that this study has exaggerated the genetic differences between samples from the Peruvian coast by not including the differentiation that may occur within an area or between parts of a single region.

Also, the number of loci examined in this study (3) may be considered low when it is considered that some authors recommend using data from 50 individuals and 20 loci (e.g., Ihssen *et al.* 1981; Utter *et al.* 1987). An

analysis of the literature on stock identification using electrophoretic data of commercially important teleosts (Smith *et al.* 1990), reveals, however, that 1 to 10 loci (average of 3.4; sd = 0.31) are commonly used.

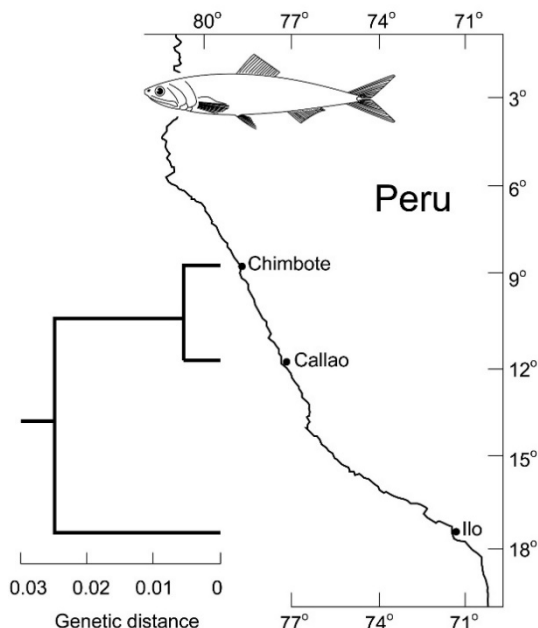

Figure 1. The coast of Peru, with the 3 cities mentioned in the text, and showing a dendrogram of genetic distance based on the phenetic relationships among three samples of the Peruvian anchoveta *Engraulis ringens*.

Although the fishery of the Peruvian anchoveta started in the 1950s, inferences on its population structure was based on some meristic and morphometrics counts and preliminary tagging- recapture data analysis. The results of these analyses suggested a separation of the anchoveta from the northern/central and southern regions, but no evidence was found for genetic differentiation between these anchoveta populations. Mathisen (1989) postulated a hypothesis of the existence of many discrete populations related to landing places along the Peruvian coast. The study of Mendo (1991), of which this contribution was the major part, was the first attempt to elucidate the population structure of the Peruvian anchoveta through a combination of phenotypic and genotypic data as well as data related to distribution, fishery and anchoveta movement.

The following two definitions from different times and points of view were taken to show the bandwidth of possible concepts: Marr (1957) defined stock as “a population or subpopulation, all members of which are characterized by similarities which are not heritable, but are induced by the environment. A stock may or may not include members of several different populations.” Another definition was given by Gulland (1971), who defined a stock or unit stock for applying models in a fishery as “a self-contained and self-perpetuating group, with no mixture from the outside, and within which the biological characteristics and impact of fishing are uniform.” While in Marr's (1955) concept, the stock may be genetically heterogeneous, Gulland's (1971) unit stock clearly refers to a genetically isolated unit, i.e., a subpopulation, a definition which is also adhered to in this study.

The first step for stock identification should be to determine if the population consists of one single group or if it is composed of isolated groups, which can be done by looking into the behavior, spawning, dynamics (growth, mortality, etc.), and genotypic variation of each subpopulation. Therefore, in Mendo (1991), data on the fishery, distribution, phenotypic, and genotypic characters as well as tagging recapture data were combined to test hypotheses on anchoveta population structure.

The lack of persistent space and time gaps in the anchoveta distribution on maps from acoustic surveys did not suggest a separation between anchoveta from the northern/central and southern regions. However, a map of egg distribution for August 1974 reported by Santander and Flores (1983) shows a gap off Punta San Juan which separates the eggs into a northern/central and a southern region. Major concentrations can be seen off



Chimbote, Callao and Mollendo. This suggests that anchoveta from the northern/central and southern regions are more or less separated during the spawning season, as also shown by tagging data from 1974 (Mendo 1991).

The data on anchoveta landings did not give sufficient evidence for stock separation. It is likely that the gaps between landing localities are not caused by gaps in the distribution of anchoveta, but rather by the topographical characteristics of the coast and the proximity to ports. This is not compatible with the hypothesis of Mathisen (1989) on the existence of small subpopulations along the Peruvian coast, all genetically adapted to different upwelling plumes. Rather, there is reproductive interchange, as also suggested by an increasing tendency for the anchoveta to spawn year-round (Muck 1989; Senocak *et al.* 1989). However, the monthly pattern of landings differed between the northern/central and southern regions, confirming the electrophoretic stock separation.

Thus, overall, the results of the electrophoretic studies presented here suggest the existence of two discrete subpopulations or stocks of anchoveta along the Peruvian coast. The stocks from the northern/central and southern region are each in Hardy-Weinberg equilibrium, as there are significant differences in allele frequencies between stocks, and Nei's genetic distances indicated a separation of southern anchoveta from those along the north/central coast of Peru.

### Acknowledgements

This contribution was extracted from my doctoral thesis at the University of Bremen, written under the supervision of Professor Daniel Pauly, and which Dr. Ulrich Damm helped edit. The field and laboratory work leading to that thesis was partially supported by the Peruvian-German Fishery Project (PROCOPA), jointly executed by the Instituto del Mar del Peru (IMARPE) and the Deutsche Gesellschaft für Technische Zusammenarbeit (GTZ). I also thank the staff of the Laboratories of Genetics, Radioisotope and Mycology of the Universidad Nacional Agraria La Molina for their help with the electrophoretic analyses.

### References

- Allendorf, F.W., N. Ryman and F.M. Utter. 1987. Genetics and fishery management, past, present and future, p. 1-20. In: N. Ryman and F. Utter (eds.). *Population genetics and fishery management*. Washington Sea Grant Program. Seattle.
- Allendorf, F.W. and F.M. Utter. 1979. Population genetics, p. 407-454. In: W.S. Hoar, D.J. Randall and J.R. Brett (eds.) *Fish Physiology*, Vol. 8. Academic Press, New York.
- Anderson, L., N. Ryman, R. Rosenberg and G. Stahl. 1981. Genetic variability in Atlantic herring (*Clupea harengus harengus*): description of protein loci and population data. *Hereditas* 95: 69-78.
- Bush, G.L. and G.B. Kitto. 1978. Application of genetics to insect systematics and analysis of species differences, p. 89-118. In: J.A. Romberger (ed.) *Biosystematics in Agriculture*. Montclair, NJ: Allanheld, Osmun.
- Buth, D.G. 1984. The application of electrophoretic data in systematic studies. *Annual Review of Ecology and Systematics*. 15: 501-522.
- Chakraborty R. and O. Leimar. 1987. Genetic variation within a subdivided population, p. 89-120. In: N. Ryman and F.M. Utter (eds.) *Population genetics and fishery management*. Washington Sea Grant Program, University of Washington Press, Seattle.
- Cruz, T.A., J.P. Thorpe, and R.S.V. Pullin. 1982. Enzyme Electrophoresis in *Tilapia zillii*: a pattern for determining biochemical genetic markers for use in tilapia stock identification. *Aquaculture* 29: 311-329.
- Cushing, J.E. 1964. The blood groups of marine mammals. *Advances in Marine Biology* 2: 85-131.
- Daly, J.C. and B.J. Richardson. 1980. Allozyme variation between populations of baitfish species *Stolephorus heterolobus* and *St. devisi* (Pisces: Engraulidae) and *Spratelloides gracilis* (Pisces: Dussumieriidae) from Papua New Guinea waters. *Australian Journal of Marine and Freshwater Research* 32:701-711
- Ferguson, A. 1980. Biochemical systematics and evolution. Blackie and Son, Ltd., Glasgow, 194 p.
- Ferguson, A. and F.M. Mason. 1981. Allozyme evidence for reproductively isolated sympatric populations of brown trout *Salmo trutta* L. in Lough Melvin, Ireland. *Journal of Fish Biology* (Dublin) 18: 629-642.
- Fujio, Y. and Y. Kato. 1979. Genetic variation in fish populations. *Bull. Jap. Soc. Fish.* 45: 1169-1178.
- Gordon, A.H. 1980. *Electrophoresis of Proteins in Polyacrylamide and Starch Gels*. Amsterdam: North Holland Publishing Co., 213 p.
- Grant, W.S. 1985. Biochemical genetics stock structure of the southern African anchovy, *Engraulis capensis* Gilchrist. *Journal of Fishery Biology* 27: 23-29.

- Grant, W.S., R.W. Leslie and I.I. Becker. 1987a. Genetic stock structure of the southern African hakes *Merluccius capensis* and *M. paradoxus*. *Marine Ecology Progress Series* 41: 9-20.
- Grant, W.S., C.I. Zhang, T. Kobayashi and G. Stahl. 1987b. Lack of genetic stock discretion in Pacific cod (*Gadus macrocephalus*). *Canadian Journal of Fisheries and Aquatic Sciences* 44: 490-498.
- Gulland, J.A. 1971. Ecological aspects of fishery research. *Adv. Ecol. Res.* 7: 115-176.
- Harris, H. and D.A. Hopkinson. 1976. *Handbook of enzyme electrophoresis in human genetics*. American Elsevier, N.Y., 306 p.
- Hedgecock, D., E.S. Hutchinson, G. Li, F. Sly and K. Nelson. 1989. Genetic and morphometric variation in the Pacific sardine, *Sardinops sagax caerulea*: comparisons and contrasts with historical data and with variability in the northern anchovy, *Engraulis mordax*. *Fishery Bulletin*. 87: 653-671.
- Hedgecock, D., K. Nelson and L.G. Lopez-Lemus. 1988. Biochemical genetic and morphological divergence among three species of herring (*Opisthonema*) in northwest Mexico. *CalCOFI Report* 29: 190-121.
- Ihssen, P.E., H.E. Booke, J.M. Casselman, J.M. McGlade, N.R. Payne and F.M. Utter. 1981a. Stocks identification: materials and methods. *Canadian Journal of Fisheries and Aquatic Sciences* 38:1838-1855.
- Ihssen, P.E., D.O. Evans, W.J. Christie, J.A. Reckahn, and R.L. Desjardine. 1981b. Life history, morphology, and electrophoretic characteristics of five allopatric stocks of lake whitefish (*Coregonus clupeaformis*) in the Great Lakes region. *Canadian Journal of Fisheries and Aquatic Sciences* 38:1790-1807.
- IMARPE. 1970. Informe del cuadro de expertos sobre dinamica de la poblaci6n de la anchoveta peruana. Report of the Panel of Experts on Population Dynamics of Peruvian Anchoveta. *Bol. Inst. Mar Peru-Callao* 2(6): 323-371.
- Jordán, R. 1971. Distribution of anchoveta (*Engraulis ringens* J.) de la zona pesquera de Huacho. *Bol. Cia. Adm. Guano* 35 (11): 1-22.
- Jordán, R. 1974. La estructura de poblaciones en peces, con especial referencia a la anchoveta *Engraulis ringens* J., 1942. Univ. Nacional Mayor San Marcos, Lima, Peru. 61 p. [Thesis].
- Kornfield, I., B.D. Sidell and P.S. Gagnon. 1982. Stock definition in Atlantic herring (*Clupea harengus harengus*): genetic evidence for discrete fall and spring spawning populations. *Canadian Journal of Fisheries and Aquatic Sciences* 39: 1610-1621.
- Lewontin, R.C. 1974. *The genetic basis of evolutionary change*. Columbia University Press, New York, 346 p.
- Market, C. and F. Moller. 1959. Multiple forms of enzymes: tissue, ontogenetic and species specific patterns. *Proceedings of the National Academy of Sciences U.S.A.* 45: 753-763.
- Marr, J.C. 1955. The use of morphometric data in systematic, racial and relative growth studies in fishes. *Copeia* 1: 23-30.
- Marr, J.C. 1957. The subpopulation problem in the Pacific sardine, *Sardinops caerulea*. *U.S. Fish and Wildlife Service Spec. Sci. Rep. Fish.* 208: 108-125.
- Mathisen, O.A. 1989. Adaptation of the anchoveta (*Engraulis ringens*) to the Peruvian upwelling system, p. 220-234. In: D. Pauly, P. Muck, J. Mendo and I. Tsukayama (eds.). *The Peruvian upwelling ecosystem: dynamics and interactions*. ICLARM Conference Proceedings 18.
- McAndrew, B.J. and K.C. Majumdar. 1983. Tilapia stock identification using electrophoretic markers. *Aquaculture* 30: 249-261.
- Mendel, G.J. 1866. Versuche über Pflanzen-Hybriden [Experiments Concerning Plant Hybrids] In: Verhandlungen des naturforschenden Vereines in Brünn [Proceedings of the Natural History Society of Brünn] IV (1865): 3-47. Reprinted in *Fundamenta Genetica*, ed. Jaroslav Kříženecký, 15-56. Prague: Czech Academy of Sciences, 1966. <http://www.mendelweb.org/Mendel.html>
- Mendo, J. 1991. Stock identification of Peruvian anchoveta (*Engraulis ringens*): morphometric, tagging/recapture, electrophoretic and ecological studies. Fachbereich 2 (Biologie), Universtät Bremen, Germany. [Doctoral thesis]
- Muck, P. 1989. Relationships between anchoveta spawning strategies and the spatial variability of sea surface temperature, p. 168- 173. In: D. Pauly, P. Muck, J. Mendo and I. Tsukayama (eds). *The Peruvian upwelling ecosystem: dynamics and interactions*. ICLARM Conference Proceedings 18.
- Nei, M. 1978. Estimation of average heterozygosity and genetic distance from a small number of individuals. *Genetics* 89: 583-590.
- Pauly, D. and I. Tsukayama. 1987. On the implementation of management-oriented fishery research: the case of the Peruvian anchoveta, p. 1-13. In: D. Pauly and I. Tsukayama (eds.) *The Peruvian anchoveta and its upwelling ecosystem: three decades of change*. ICLARM Studies and Reviews 15.

- Prakash, S., R.C. Lewontin and J.L. Hubby. 1969. A molecular approach to the study of genetic heterozygosity in natural populations IV. Patterns of genetic variation in central, marginal and isolated populations of *Drosophila pseudoobscura*. *Genetics* 61:841-858.
- Richardson, B.J., P.R. Baverstock and M. Adams. 1986. *Allozyme electrophoresis*. A handbook for animal systematics and population studies. Academic Press, Australia, 409 p.
- Ryman, N. 1983. Patterns of distribution of biochemical genetic variation in salmonids: Differences between species. *Aquaculture* 33: 1-21.
- Santander, H. and R. Flores. 1983. Los desoves y distribución larval de cuatro especies pelágicas y sus relaciones con las variaciones de! ambiente marino frente al Perú, p. 835-867. In: G.D. Sharp and J. Csirke (eds.) *Proceedings of the Expert Consultation to examine changes in Abundance and Species of Neritic Fish Resources, 18-29 April 1983, San José, Costa Rica*. FAO Fish. Rep. 291 (3), Rome [In Spanish with English abstract].
- Sargent, J.R. and S.G. George. 1975. *Methods in Zone Electrophoresis*. B.D.H. Chemicals, Poole, Dorset, England, 219 p.
- Şenocak, T., D. Schnack and D. Pauly. 1989. Mean monthly distribution, abundance and production of anchoveta eggs off Peru (4-14° S), 1964-1971 and 1972-1986, p. 143-154. In: Pauly, D., P. Muck, J. Mendo and I. Tsukayama (eds). *The Peruvian upwelling ecosystem: dynamics and interactions*. ICLARM Conference and Proceedings 18.
- Serra, J.R., M. Aguayo, O. Rojas, J.R. Canon y F. Inostroza. 1979. Anchoveta *Engraulis ringens* (Jenyns) Teleostomi Clupeiformes Engraulidae. Corporación de Fomento de la Producción (AP 79-18). *Inst. Fom. Pesq. Chile*. 52 p.
- Shaklee, J.B. 1983. The utilization of isozymes as gene markers in fisheries management and conservation. *Current topics in Biological and Medical Research* 11: 213-247.
- Smith, I. 1976. *Chromatographic and Electrophoretic Techniques*. Volume II, Zone Electrophoresis. London, Heinemann Medical Books Ltd., 485 p.
- Smith, P.J. and Y. Fujio. 1982. Genetic variation in marine teleosts: high variability in habitat specialists and low variability in habitat generalists. *Marine Biology* 69: 7-20.
- Smith, P.J., A. Jamieson and A.J. Birley. 1990. Electrophoretic studies and the stock concept in marine teleosts. *J. Cons. int. Explor. Mer* 47: 231-245.
- Sneath, P.H.A., and R.R. Sokal. 1973. *Numerical taxonomy*. W.H. Freeman, San Francisco, CA, 573 p.
- Soulé, M. 1976. Allozyme variation: its determinants in space and time, p. 60-77. In: F.J. Ayala (ed.) *Molecular evolution*. Sinuaer, Sunderland, Massachusetts.
- Spanakis, E., N. Tsimenides and E. Zouros. 1989. Genetic differences between populations of sardine *Sardina pilchardus* and *Engraulis encrasicolus* in the Aegean and Ionian Seas. *Journal of Fisheries Biology* 35: 417-437.
- Stahl, O. 1987. Genetic population structure of Atlantic salmon, p. 121-140. In: Ryman and F. Utter (eds.) *Population genetics and fishery management*. Washington Sea Grant Program, University of Washington Press, Seattle.
- Tsukayama, I. 1966. El número de branquias como caracter diferencial de sub- poblaciones de anchoveia (*Engraulis ringens* Jenyns) en la costa del Perú, p. 139-145. En: Memoria Ier Seminario Latino-Americano Sobre el Oceano Pacifico Oriental. Universidad Nacional Mayor de San Marcos, Lima, Perú. [Thesis]
- Utter, F., P. Aebersold and G. Winans. 1987. Interpreting genetic variation detected by electrophoresis, p. 21-46. In: N. Ryman and F. Utter (Eds.) *Population genetics and fishery management*. Washington Sea Grant Program, University of Washington Press, Seattle.
- Vrooman, A.M., P.A. Paloma and J.R. Zweifel. 1981. Electrophoretic, morphometric, and meristic studies of subpopulations of Northern anchovy, *Engraulis mordax*. *Calif. Fish and Game* 67(1): 39-51.
- Watson, J.D. and F.H.C. Crick. 1953. A Structure for Deoxyribose Nucleic Acid. *Nature* 171(3): 737-738.
- Winans, G. 1980. Geographic variation in the milkfish *Chanos chanos*. I. Biochemical evidence. *Evolution* 34: 558-574.
- Witt, G.S. 1970. Developmental genetics of the lactate dehydrogenase isozyme of fish. *Journal of Experimental Zoology* 175:1-36.

## LOCALISM VS. UNIVERSALISM IN SCIENCE: VIGNETTES FROM FISHERIES RESEARCH\*

Daniel Pauly

*Sea Around Us, Institute for the Oceans and Fisheries, 2202 Main Mall, University of British Columbia,  
Vancouver, Canada*  
[d.pauly@oceans.ubc.ca](mailto:d.pauly@oceans.ubc.ca)

### Abstract

Five vignettes are presented of fisheries research themes that have ‘local’ interpretations (i.e., ‘it applies only to here’, or ‘it applies only to this taxon’) and more general interpretations, reducible to first principles, here called ‘universal’. These examples, derived from the authors work, refer to: 1) the natural mortality of fishes; 2) the factor(s) limiting size and growth in gill-breathing animals; 3) the integration of single-species stocks into ecosystem models; 4) the global decline, in the last decades, of mean trophic levels in the catch of marine and freshwater fisheries; and 5) the mechanism now known as ‘Malthusian overfishing’ which explain the destructive trends reported from many small scale fisheries in developing countries.

There are, for each occurrence of the processes involved in these examples, ‘localists’ who will argue for the uniqueness of that occurrence. The case is made that keeping a universalist perspective should result in more insights and in predictability, i.e., in more of the very ‘stuff’ of Science. Moreover, universalism is the logical conclusion of a scientific ethos that is inclusive and which leads, perhaps paradoxically, to a wide diversity of scientific players having to be taken seriously by the scientific community.

### INTRODUCTION

Ladies and Gentlemen, representatives of the sponsoring organizations: let me first express my appreciation for having been invited to speak to this audience, in the august setting of a Pre-ICES Conference.

Before getting into the substance, if any, of my talk, I must, however, briefly correct two items related to the timing of this conference: first, it is not ‘August’ that I wanted to say, since today is the 24<sup>th</sup> of *September*; and second, this conference is called a ‘Pre-ICES conference.’ This cannot possibly be: nothing can be as old as ICES, let alone be ‘Pre-ICES.’

### First vignette: the locus of our fears

This brings to my opening scene, 20 ICES Science Conferences ago, in Copenhagen, where for the first time, I presented a paper at an ICES meeting. I was terrified: here I was claiming to have found something new, while, in the audience, several of the ‘living books’ and ‘living papers’ sat whom I had previously seen gliding about: David Cushing, Ray Beverton, John Gulland, Rodney Jones, and others who had been, in my student days, the stuff of elation when I understood a piece of their writing, and of nightmares when, more frequently, I didn’t.

There they sat, listening as I presented my results, waiting to trip me, I thought. Doubtlessly, one would stand up and, in fluting British accent, point at some elementary error in my reasoning, thus destroying me forever... Well, it did not happen. Rather, they nodded gravely, then went on mumbling to themselves. And later, when I got to know them, I found out about their foibles and their own fears, and I discovered the key reason graduate students and young scientists should be encouraged to attend international conferences and meet the living books and papers: it is to discover that they are people, not books or papers, and that hence, being people, anyone of us can become a living book or paper. This is my first point about ‘localism’ - referring to the *locus* of

---

\* Cite as Pauly, D. (2018) “Localism vs. Universalism in science: vignettes from fisheries research,” Pp. 27-32. *In* Pauly D. and V. Ruiz-Leotaud (eds.) Marine and Freshwater Miscellanea. Fisheries Centre Research Reports 26(2). Institute for the Oceans and Fisheries, University of British Columbia. This contribution is based on a presentation at the Pre-ICES Conference Meeting, September 24, 1997, Baltimore, Maryland, USA, sponsored by the National Marine Fisheries Service, the National Science Foundation, Atlantic States Fisheries Commission, Morgan State University, and the Columbus Center, Baltimore, and attended mainly by ‘minority’ graduate students and young scientists.

our personal fears - vs. -universalism' - the fact that all colleagues I have come to know well turned out to have their own limitations and the fears resulting from them. They would not have been scientists if they had not: smugness is not appropriate when you are treading in an ocean of ignorance.

At that time, and I am here referring to 1978, fisheries research was, at least in the North Atlantic area, in the throes of a transition from a belief in the wholesomeness of Yield-Per-Recruit analyses, to a belief in the efficacy of Virtual Population Analysis, two approaches which we now know relate to the ills of our fisheries as aspirin, and cough syrup, respectively, relate to terminal cancer.

Estimates of the natural mortality rate ( $M$ ) of fish population were needed for both of these methods, but only few values were available, mainly from a ground breaking paper by Beverton and Holt (1959).

They had assembled, mainly from the key *loci* of fisheries research, the North Sea, and surrounding North Atlantic areas, about 50 values of  $M$ , mostly as estimated by them, and shown these to be strongly related, within groups of fish - the cod likes, the herring likes, the flatfish, etc., to their growth rate, as expressed the parameter of the equation conventionally used to represent fish growth.

Having worked in Indonesia, Southeast Asia, in 1975-1976, I had become quite aware of the limitation of their and similar empirical relationships, which among other omitted groups, did not cover tropical fish. Thus, I extended the data set assembled by Beverton and Holt, and sought to identify variables that would extend the applicability of the models they had derived: I sought a broad relationship, which would apply to all fish, everywhere on Earth, and thus be 'universal' (for the Earth is still our universe, much as we may like *Star Trek*, Mr. Spock and Lieutenant Uhura, and their vision of the Universe). This data set I then used to show that natural mortality, in fish, is a function of their size, of their growth rate, and of the water temperature they are exposed to, while other factors previously thought to be important, such as their taxonomic affinities, turned out to be largely irrelevant. This was what I had to present at the above-mentioned 1978 ICES meeting (Pauly 1978) and, in retrospect, I can see that I had nothing to fear from my assembled older colleagues. Indeed, the extended journal version of that contribution (Pauly 1980) became my most-cited paper ever, and to some, I am the living paper 'On  $M$ .'

Score one for universalism, even if we now need to know how natural mortality changes, rather than just use mean values.

### Second vignette: oxygen as limiting factor in fish growth

My next vignette refers to a potentially universal idea, which I have much more trouble getting across. It deals with fish growth, which is important in fisheries research since it is that growth which generates the yields of fisheries. The question is whether there is a basic, universal principle behind the different, local manifestations of fish growth, and whether this can be used to make predictions. I attacked this problem by asking what determines the maximum size of organisms, and hence the world they live in, and virtually all most of their vital statistics (Peters 1983; Calder 1984; Schmidt-Nielsen 1984; Goolish 1991). One could answer it is their 'genes,' or their 'ecology,' but this would still require that we identify the *mechanism* through which the genes, or the ecology express themselves, e.g., through a lower Darwinian fitness for those individuals that are not of the right size.

Moreover, a universal explanation - if there is to be one - should not be purely biological, as there would be as strong premium for organisms to quickly evolve around biological constraints to their size. A strong contender for a non-biological constraint to the size of organisms is *geometry*, specifically the interplay of the power of length in proportions of which body volume grows, relative to the power of length in proportion of which different surfaces can grow, of which one will end up limiting size. The limiting surface itself varies among media, i.e., among organisms living in water, or in air, but on the ground, or which fly, and also varies among the different architectures, of *Bauplan*, that organisms may have. We shall here consider only animals, although the principle applies to plants, or bacteria.

In terrestrial mammals and in birds, the interplay in question is that between the volume of the body wherein heat is produced, and the body surface through which heat is lost. One of the results of this is Bergmann's Rule, stating that mammals and birds of low latitudes will tend to be larger (and have relatively shorter extremities) than their low-latitude congeners (Bergmann 1847). In very large mammals, however, so much heat may be



generated during bouts of activity that surfaces have evolved for its dissipation (e.g., the large, fan-like, mobile ears of elephants, or flukes with counter-current heat exchanger of whales). The principle involved here can be checked in physics textbooks and leave little for biologists to argue about.

Another volume-to-surface interplay occurs in terrestrial organisms, where weight, growing in proportion to length cubed, must be accommodated by legs whose resistance is proportional to their cross-sectional area, i.e., to  $\pi \cdot r^2$ . Hence, gravity dictates the thin legs of passerine birds, the ostrich-like legs of ostriches, and the elephant-like legs of moas (Thompson 1942).

In insects, respiration occurs through a cotton-like network of trachea, bringing oxygen to, and taking CO<sub>2</sub> from individual body cells. This surface-limited system is so inefficient that it almost entirely fills up larger insects, forever precluding the huge 'Bug' that is finally squished by *Men in Black*.

For fish, squids and other animals breathing water through gills, gravity is not a problem - the reason why the largest invertebrates (giant squids) and vertebrates (whales) live in the sea, and not on land (Angel 1976). On the other hand, water is a difficult medium from which to extract oxygen: there is typically 30 times less O<sub>2</sub> in water than in air, water is 55 times more viscose than air, while the diffusion of O<sub>2</sub> in water is a staggering 300,000 times slower than in air. Thus, fish may spend up to 40% of their resting metabolism on breathing itself, a figure much higher than e.g., in humans, where only 2% of resting metabolism is used for breathing itself (Schuman and Piiper 1966).

In gill-breathers, oxygen uptake is proportional to gill surface area (Pauly 1981). Thus, large fish have higher oxygen uptakes than small fish of the same species. However, the weight-specific or 'relative' oxygen uptake of larger fish is bound to be less than that of their small congeners, given that their gills - a surface - cannot grow as fast as their volume, and hence their demand for oxygen. Thus, there must be, for any species of fish or other water-breathing animals, a level of oxygen supply that is just sufficient to meet the routine metabolism appropriate to a certain habitat. This defines, for a given species, the maximum weight ( $W_{max}$ ) that can be reached in a given environment.

Now the interesting thing about this is that it explains a multitude of processes normally not seen to be related to respiration and growth, notably how temperature determines maximum size, how daily pH changes induced by different levels of activity generate daily rings in otoliths, how respiratory stress induces maturation, etc.

Moreover, these processes can be expressed in the form of testable, quantifiable hypotheses (Pauly 1981, 1984, 1997b; Longhurst and Pauly 1987; van Dam and Pauly 1995). Yet until recently, no independent testing of the hypotheses generated by this theory, or its corollaries, has been performed. Rather, they have tended to be dismissed, usually with frivolous arguments (see e.g., Weatherley and Gill 1987). Indeed, an anonymous referee once went to the heart of the matter, angrily writing across the page of a report "May apply in the tropic, but not here." I have elaborated elsewhere on some implications of this telling statement (Pauly 1994), and shall here only point at the unthinking localism that it expresses. Still they win here (at least for now): localism 1, universalism 0\*.

### Third vignette: no fish is an island

Localism, in fisheries science is what makes us look at the resources one species at a time, as if they were not interacting simultaneously. Localism is thus overcome when we establish feeding or other links among the species co-occurring in a given ecosystem, notwithstanding the local experts who tell you it cannot be done, because their species is 'too different' to be linked with others in the context of an ecosystem model. Yet here again, there is a sound basis for universalism: it is the Second Law of Thermodynamics, which states that energy can be neither created nor destroyed. This implies, in the context of our discipline, that the fish stock we study can only be as large as there is food to sustain them, however much the local fishers wish it be otherwise. This also implies, conversely, that if these fish population persist, it is because there must be enough food for them, whatever the local expert on their food organisms may say.

Putting this into use for fisheries research is straightforward, and has led to a now much-used approach and software called Ecopath (Polovina 1984; Christensen and Pauly 1992), whose applications to various systems has

---

\* This is changing now that ocean warming is becoming evident...

led to rigorous descriptions of a large number of ecosystems for which such syntheses had remained elusive (see Christensen and Pauly 1993) and new insights about their functioning. One of these is that fisheries impacts on marine system are much stronger than assumed before: on the shelves from which 90% of marine catches originate, between 25 and 35% of observed primary production is required to sustain the fisheries (Pauly and Christensen 1995).

It is localists who say that that “you can’t compare apples with oranges.” Actually, these two kinds of fruits are easy to compare: you can compare their caloric or vitamin contents, their absorption spectrum before or after they are pulped, their yield per area, their price, you name it. Similarly, localists will tell you that ecosystems are too complex to be reduced to ‘mere models,’ and that they cannot be compared, each having its own individual features – again as do apples or oranges, which we still can compare (Downing 1991). Here we have a clear 1 to 0 for universalism.

#### **Fourth vignette: fishing down marine food webs**

The ecosystem analyses mentioned above yielded among other things, a large number of estimates of trophic levels, notably for all groups represented in the FAO catch statistics, the only set of statistics we have for the fisheries of the entire world, and covering the years 1950 to the mid-1990s. Multiplying these annual catch figures, for the 1,300 statistical categories distinguished by FAO, by the best corresponding estimates of trophic level led to estimates of the mean trophic level of the world fisheries catches, by year. This showed that the mean trophic level of the world’s fisheries has been declining steadily in the last two decades, for both marine and freshwater fisheries. Thousands of numbers, from the over 150 member countries of FAO, went into the data point for a given year. Yet, in spite - or rather - because of these large amounts of independent inputs, a clear pattern emerged: all over the globe, fisheries are moving down the food webs, and destroying their own ecological basis - whatever localists say about *their* fisheries being immune to such trends. This is too sad to gloat about, and here, we won’t keep the score\*.

#### **Fifth and last vignette: even in social science...**

It is not news that fisheries, globally, are in deep trouble, and the main culprits have been identified: open access regimes, massive subsidies, etc. In the course of my work in developing countries in Africa, South America, and Asia, all very diverse, all with their local peculiarities, I have come to identify a particular set of processes leading to destruction of small-scale fisheries which I believe are universal - at least in developing countries.

I have called this set of processes ‘Malthusian overfishing’ (Pauly 1990, 1994, 1997a). It essentially consists of landless farmers establishing themselves on coastlines, and competing there with ‘traditional’ fishers for access to nearshore fish resources, using whatever methods they can, and often destructive ones. The concept and its name have caught among colleagues working on developing-countries fisheries, so much indeed that it is now often mentioned without reference to its author, a process known as ‘recognition by obliteration’ (Garfield 1975). Thus, even in the social science arena, where localism usually reigns supreme, generalizations can be made, thus allowing case-by-case descriptions to become the stuff of science, i.e., of testable hypotheses with more than local scope.

#### **Generalization: why universalism was good for me**

All five of the vignettes, or short stories, that I recalled above implied that I had to ‘join battle’ with local experts, i.e., colleagues who had specialized on one or the other area of fisheries science, specific places or taxonomic groups. There have been more of these battles, not mentioned here, involving e.g., the appropriateness of length-frequency analysis for estimating growth and mortality of fishes (see contributions in Pauly and Morgan 1987), the relevance of anecdotal evidence in evaluating past resources states (Pauly 1995), or the proper design of databases on the biology of fishes (see Froese and Pauly 1997). The response of the local experts was in many cases quite vehement, but rarely unprofessional: they wrote papers suggesting I was wrong, or that my generalizations did not apply to their cases - but they kept inviting me to their meetings.

Thus, for example, a colleague who thought (and probably still thinks) that my gill-oxygen limiting theory (see above) does not apply to his squids (Lipinski and Roedefeld, 1990) invited me to present it at a meeting on

---

\* However, you can see it at [www.fishingdown.org](http://www.fishingdown.org).

squids - which I did (Pauly 1997b). This was possible, obviously, because of a shared scientific ethos, a common belief that there is an objective reality 'out there,' which is our task as scientist to describe and to make sense of (see also Medawar 1967). I do not believe, as many social scientists appear to, that the contents of science are predominantly a 'social construct,' the result of negotiations among holders of power, whose claims to objective knowledge must be 'deconstructed.' In fact, while obviously accepting that social processes, status, and power games influence the way scientific knowledge is gained, stated and used, I also believe the deconstructionist school to be profoundly mistaken in its view of the methods and contents of Science.

Thus, while it is true that the leaders of a scientific field exert interpretative and other form of power in that field (e.g., by favourably or unfavourably reviewing grant applications), it is also true that this power has largely granted to them, *by their peers*, because of their earlier scientific achievements. Scientific 'power' is not hereditary, as are e.g., monetary wealth, and the political power derived therefrom. Moreover, the deconstructionist school renders a great disservice to the groups previously or still excluded from full participation in Science, but which it purports to represent. Thus, members of disadvantaged groups without recourse to an objective reality 'out there' would never be able to contribute to a game that involves only negotiations among powerful managers of orthodox opinion. And neither could members of these marginalized groups contribute to knowledge that is valid only locally, but for which local experts already exist. Rather, all they could do is open a forum for discussion among themselves, emphasizing *their* local expertise, and undermining efforts such as this meeting. [See also Brown 1988, 1991; Brown and Duffie 1992; and Jearld 1995, or the contributions in *Current, the Journal of Marine Education*, Vol. 4(1), 1982, and *Fisheries*, Vol. 6(4), 1992]. I remember for example attending, in the mid-1980s, a symposium in Peru at which a group of young people, who should have been colleagues, decided instead to create an 'Andean Science' that would be more relevant to their experience and the need of their communities than 'Orthodox Science,' which, they felt, had failed them.

The universalist alternative to this, while recognizing the worth of locally-based knowledge, argues that such knowledge is incomplete if not articulated such that it links with the body of Science as a whole, which reflects the totality of human experience, everywhere on Earth. In 1978, when, at my first ICES meeting I addressed the living books, I spoke to them of the natural mortality of fish *anywhere*. Thus, even if interested only in the North Sea, they had to listen to me, then or later. However, they would have kept me out of their pages, had it not been otherwise. And I would not have been invited to address you here. Thank you.

## Acknowledgements

I wish to thank Ambrose Jearld, for interesting, though excessively sporadic exchanges, and for the invitation to attend this meeting, and Bradford Brown, for his interest in my career, starting from the above-mentioned ICES Meeting in 1978 at which, I admit, I publicly criticized an innovating paper of his.

## References

- Angel, H. 1976. *Monsters of the deep: sharks, giant squid, whales and dolphins*. Octopus Books, London, 128 p.
- Beverton, R.H.J. and S.J. Holt. 1959. A review of the lifespans and mortality rates of fish in nature and their relation to growth and other physiological characteristics. p. 142-180 In G.E.W. Wolstenholme and M. O'Connor (eds). *Ciba Foundation on ageing: the lifespans of animals*. Vol. 5, J. & A. Churchill, London.
- Brown, B.E. 1988. Establishing linkages with historically black colleges and universities: a report on a panel discussion at the 1987 American Fisheries Society Annual Meeting. *Fisheries* 3(5):26-27
- Brown, B.E. 1991. Savannah State College: an important link in the marine science network. *Current, the Journal of Marine Education*, 10(4):8-11.
- Brown, B.E and E.C. Duffie 1992. Beyond affirmative action - strategy for the next century. Paper presented at the September 1992 Meeting of the American Fisheries Society; 5 p. [available from the first author, NMFS, Southeast Fisheries Science Center, Miami].
- Calder, W.A. 1984. *Size, Function and Life History*. Harvard University Press, Harvard.
- Christensen, V. and D. Pauly. 1992. The ECOPATH II - a software for balancing steady-state ecosystem models and calculating network characteristics. *Ecol. Modelling* 61: 169-185.
- Christensen, V. and D. Pauly. (Editors) 1993. Trophic models of aquatic ecosystems. ICLARM Conference Proceedings 26, Manila, 390 p.
- Downing, J.A. 1991. Comparing apples with oranges: methods of intersystem comparisons. P. 24-45 In J. Cole, G. Lovett and S. Findlay (eds). *Comparative analysis of ecosystems: patterns, mechanisms and theories*. Springer Verlag, New York.



- Froese, R. and D. Pauly. 1997. *FishBase 97: concepts, design and data sources*. ICLARM, Manila, 257 p.
- Garfield, E. 1977. The 'obliteration' phenomenon in science and the advantage of being obliterated. p. 396-398  
In: E. Garfield. *Essays of an information scientist*. Institute for Scientific Information, Philadelphia.
- Goolish, E. 1991. Aerobic and anaerobic scaling in fish. *Biol. Rev.* 66:33-56.
- Jearld, A. Jr. (Editor). 1995. Expanding opportunities in ocean sciences: strengthening the links between HBMSU undergraduates and oceanic graduate studies. Proceedings of a conference held on September 11-12, 1995 at Hampton University, Hampton Virginia. *Northeast Fish. Sci. Cent. Ref. Doc.* 96-08, 100 p. [available from NMFS, 166 Water Street, Woods Hole, MA 02543-1026]
- Lipinski, M. and M.A. Roeleveld. 1990. Minor extension of the von Bertalanffy growth theory. *Fisheries Research.* 9:367-371.
- Longhurst, A.R., and D. Pauly. 1987. *Ecology of tropical oceans*. Academic Press, San Diego, 407 p.
- Medawar, P.B. 1967. *The art of the soluble*. Methuen, London, 160 p.
- Paula e Silva, R., M.I. Sousa and A.M. Caramelo. 1993. The Maputo Bay ecosystem (Mozambique) p. 214-223 In V. Christensen and D. Pauly. (eds). 1993. *Trophic models of aquatic ecosystems*. ICLARM Conference Proceedings 26, Manila.
- Pauly, D. 1978. A discussion of the potential use in population dynamics of the interrelationships between natural mortality, growth parameters and mean environmental temperature in 122 fish stocks. *ICES CM* 1978/G:21, 36 p.
- Pauly, D. 1980. On the interrelationships between natural mortality, growth parameters and mean environmental temperature in fishes. *J. Con. int. Explor. Mer.* 39(3): 175-192.
- Pauly, D. 1981. The relationship between gill surface area and growth performance in fishes: a generalization of von Bertalanffy's theory of growth. *Meeresforsch.* 28(4):251-282.
- Pauly, D. 1984. A mechanism for the juvenile-to-adult transition in fishes. *J. Cons. int. Explor. Mer.* 41:280-284.
- Pauly, D. 1990. On Malthusian overfishing. *Naga, the ICLARM Quarterly.* 13(1): 3-4.
- Pauly, D. 1985. Zur Fischereibiologie tropischer Nutztier: eine Bestandsaufnahme von Konzepten und Methoden. *Berichte des Instituts für Meereskunde and der Universität Kiel* (147), 155 p.
- Pauly, D. 1994. *On the sex of fish and the gender of scientists: a collection of essays in fisheries science*. Chapman and Hall, London, 250 p.
- Pauly, D. 1995. Anecdotes and the shifting baseline syndrome of fisheries. *Trends in Ecology and Evolution.* 10(10): 430.
- Pauly, D. 1997a. Small-scale fisheries in the Tropics: marginality, marginalization and some implications for fisheries management. In E.K. Pikitch, D.D. Huppert, and M.P. Sissenwine (eds). *Global trends in fisheries management*. American Fisheries Society Symposium, Bethesda, Maryland.
- Pauly, D. 1998. Why squids, though not fish, may be better understood by pretending they are. p. 47-58. In: A.I.L. Payne, M.R. Lipinski, MR. Clarke, and M.A.C. Roeleveld (eds.) *Cephalopod biodiversity, Ecology and Evolution. South African Journal of Marine Science* 20.
- Pauly, D. and V. Christensen. 1995. Primary production required to sustain global fisheries. *Nature*, 374: 255-257.
- Pauly, D. and G. Morgan (Editors). 1987. *Length-based methods in fisheries research*. ICLARM Conference Proceedings 13. International Center for Living Aquatic Resources Management, Manila.
- Peters, R.H. 1983. *The ecological implications of body size*. Cambridge University Press, Cambridge.
- Polovina, J.J. 1984. Model of a coral reef ecosystem: I: the Ecopath model and its application to French Frigate Shoals. *Coral Reefs* 3(1): 1-11.
- Schmidt-Nielsen, K. 1984. *Scaling: why is animal size so important?* Cambridge University Press, Cambridge.
- Schuman, D. and J. Piiper. 1966. Der Sauerstoffbedarf der Atmung nach Messungen an der narkotisierten Schleie (*Tinca tinca*). *Pflüger's Archiv.* 288:15-26.
- Thompson, D. 1942. *Growth and form*. Cambridge University Press, Cambridge, 651 p.
- Van Dam, A. and D. Pauly 1995. Simulation of the effects of oxygen on food consumption and growth of Nile tilapia, *Oreochromis niloticus* (L.). *Aquaculture Research* 26: 427-440.
- Weatherley, A.H. and H.S. Gill 1987. *The biology of fish growth*. Academic Press, London, 443 p.

## WHAT ARE GLOBAL FISHERIES STUDIES?\*

Daniel Pauly<sup>1</sup>, William Cheung<sup>2</sup> and U. Rashid Sumaila<sup>3</sup>

- <sup>1)</sup> *Sea Around Us, Institute for the Oceans and Fisheries, 2202 Main Mall, University of British Columbia, Vancouver, Canada*
- <sup>2)</sup> *Changing Ocean Research Unit, Institute for the Oceans and Fisheries, University of British Columbia, Vancouver, B.C. Canada, V6T 1Z4*
- <sup>3)</sup> *Fisheries Economics Research Unit, Institute for the Oceans and Fisheries, University of British Columbia, Vancouver, B.C. Canada, V6T 1Z4*  
[d.pauly@oceans.ubc.ca](mailto:d.pauly@oceans.ubc.ca), [w.cheung@oceans.ubc.ca](mailto:w.cheung@oceans.ubc.ca), [r.sumaila@oceans.ubc.ca](mailto:r.sumaila@oceans.ubc.ca)

### Abstract

Given the proliferation of studies of fisheries with the word ‘global’ in the title, this essay provides stringent criteria for what should count as studies that allow for global inferences, as opposed to studies which claim to be global, e.g., because they rely on widely dispersed, subjectively selected case studies. Some contrasting examples are provided.

### Introduction

Decades before the first photo of the Earth’s globe was taken from space in 1972 (Figure 1), the United Nations (U.N.) created a global statistical system for various commodities and socio-economic indicators. Their idea of ‘global’ was complete, even if their statistics were not (in the case of fisheries, for instance, discarded fish and small-scale fisheries catches are often overlooked). Studies that provide us with a truly global view of different aspects of the world oceans are extremely important to inform policies on how to manage their resources, particularly when they pertain to the High Seas.

Four types of global studies may be identified: (1) global census-like studies, such as those carried out by the UN, that are based on standardized information pertaining to all countries in the world, or to all components of the global ocean; (2) sample-based studies - when they are based on geographically representative samples and/or effort that allow imputation or extrapolation to the entire ocean (or to all maritime countries of the world); (3) model-based studies whose domain cover the global oceans; (4) global assessments such as those conducted by the Intergovernmental Panel on Climate Change (IPCC) and the Intergovernmental Science-Policy Platform on Biodiversity and Ecosystem Services (IPBES).

Given global-scale environmental challenges that we are now facing, such as overfishing, climate change, and biodiversity loss, we argue that encouraging global studies of fisheries-related activities will contribute to a better understanding of the problems that beset our oceans, and of those whose livelihoods depend on fisheries, and assist in identifying solutions that are generous, i.e., potentially apply to all people, wherever they are, particularly residents of areas that are often underrepresented in conventional case study based approaches.

### Global issues and fisheries

Many key environmental issues relating to marine fisheries are global in nature, e.g., overfishing, climate change, and biodiversity loss. However, conventional approaches in studying fisheries are not global in nature, thus often falling short on providing the scientific advice that is needed to inform policies that effectively addresses these issues.

---

\* This essay is adapted from the website of the *Global Fisheries Cluster* of UBC’s Institute for the Oceans and Fisheries, founded by the 3 authors. Cite as: Pauly, D., W.W.L. Cheung and Sumaila, U.R. (2018) “What are Global Fisheries Studies,” Pp. 33-37. In Pauly D. and V. Ruiz-Leotaud (eds.) *Marine and Freshwater Miscellanea*. Fisheries Centre Research Reports 26(2). Institute for the Oceans and Fisheries, University of British Columbia.

Conducting global studies in fisheries is possible, as has been done in other disciplines. Since the stunning ‘blue marble’ photos of Earth taken from space by the Apollo 17 crew, on December 7, 1972 (Figure 1), the understanding of Earth as one living and breathing system has grown among people, as has the fact that this system consists mainly of sea water. However, the community studying terrestrial ecosystems (e.g., terrestrial primary production; Lieth 1973), and those studying the weather, the climate, and the oceans have performed global analyses for over half a century (see e.g., Edwards 2010; Sverdrup *et al.* 1942).



Figure 1: A ‘blue marble’ photo of Earth taken from space by the Apollo 17 crew, on December 7, 1972.

Similarly, the United Nations (U.N.), right after the Second World War, created global statistical systems for various commodities and socio-economic indicators (Ward 2004) devoted to assisting in post-war economic reconstruction and development. For fisheries, this mainly consisted of details on their global catch (or more precisely: landings), published annually, by country, since 1950 by the Food and Agriculture Organization of the U.N. (FAO; Garibaldi 2012). This dataset is extremely useful for fisheries research, which tends to consist of local studies that are inherently difficult to synthesize. Particularly, recent works by the *Sea Around Us* and its international network of collaborators have increasingly improved the usefulness of global catch data by filling in gaps, correcting errors and biases and making the data widely available for the community of researcher (see Pauly and Zeller 2016 and [www.seaaroundus.org](http://www.seaaroundus.org)).

In contrast to the above approaches, most other fisheries researchers have tended to either ignore the deficiencies of the FAO data because “that’s all we have”, or attempted to compensate for this through ‘case studies,’ which cannot be taken as representative of anything because the class (of cases) that these studies are supposed to be representative of is never specified. This is best illustrated in the study of Worm, Hilborn *et al.* (2009), which purported to be ‘global,’ but included among its 67 case studies only 5 representing the bulk of Asia, Latin America, and Africa (Figure 2), while 62 originated from the US (mainly Alaska), Canada, Western Europe, Australia, and New Zealand. The geographic bias that is built in this figure is partly masked by the authors’ use of a Mercator projection, which emphasizes high-latitude areas (Figure 2). When an equal area projection is used, the full extent of this bias becomes clearly evident (Figure 3).

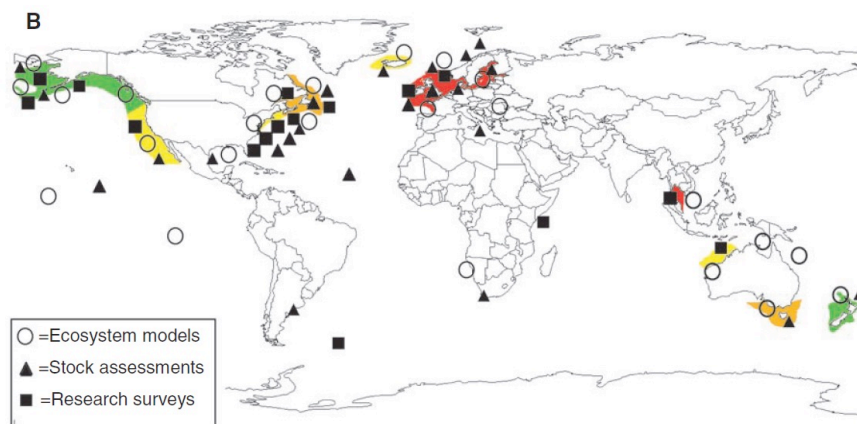

Figure 2: Illustrating the geographic bias in Worm, Hilborn *et al.* (2009, Figure 6), who based their pronouncements on the state of 'global fisheries' on a data set that was strongly biased towards the reasonably well-managed fisheries of wealthier, developed countries (see also Figure 3 for contrast).

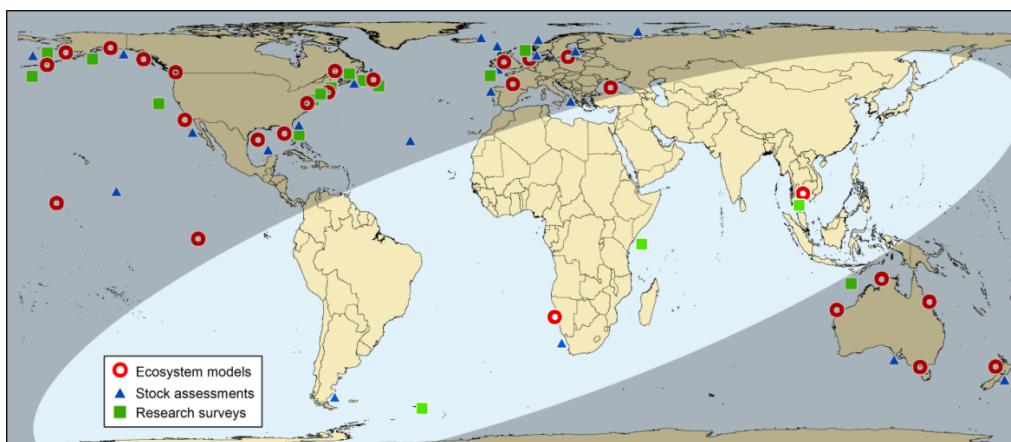

Figure 3: A version of Figure 6 in Worm, Hilborn *et al.* (2009) showing that about half of the oceans was represented by only 7 case studies, while 59 case studies were used for the remaining half, mainly off the coast of countries with which these authors were more familiar.

## Criteria for global fisheries studies

Samples that are biased to the extent shown in Figure 3 should not be used for any studies, and the time has come for fisheries science to overcome the cavalier attitude that goes along with studies of this sort. Thus, sample-based studies meant to be 'global studies' should be based on a geographically unbiased sampling design and contain explicit extrapolation to the entire ocean (or all maritime countries of the world). Good examples of this former approach, based on a rigorous sampling design, do not really appear to exist in fisheries science; however, they exist in other disciplines, e.g., anthropology (see McNett and Kirk 1968). Clearly, work on this is needed.

One alternative to sample-based studies are census-like studies, such as usually performed by U.N. agencies. Global census-like studies are based on standardized information pertaining to all countries in the world, or to all components of the global ocean. Numerous examples of this approach exist, e.g., as performed by the *Sea Around Us* (e.g., Campbell and Pauly, 2013; Pauly *et al.* 2014; Tremblay-Boyer *et al.* 2011; Pauly *et al.* 2016) and the *Fisheries Economics Research Unit* of the IOF (Cisneros-Montemayor and Sumaila 2010; Swartz *et al.* 2013; Sumaila *et al.* 2010, 2015, 2016; Lam *et al.*, 2016).

By developing statistical and mechanistic models that cover the global ocean, studies can synthesize available information to assess the current status of global fisheries, and evaluate scenarios for their evolution. Traditional fisheries modeling focuses on single stocks in particular region, e.g., cod in the Gulf of Maine. However, with the

realization of global scale stressors, such as climate change and ocean acidification, on world fisheries and associated issues such as global seafood security and transboundary fisheries governance, the need for global fisheries models has become apparent. One example is the evolving *Dynamic Bioclimate Envelope Model* developed by the *Changing Ocean Research Unit* of the IOF and its collaborators, which is the first global spatially-explicit fisheries models, and which can project changes in potential catches under scenarios of climate change and fishing (Cheung *et al.* 2010, 2013, 2017).

In addition, global environmental assessments such as the Assessment Reports of the IPCC and IPBES Global and Regional Assessment synthesize global and local data and information to answer global-scale questions. These data and information include global-scale quantitative datasets and modelling outputs as described above, as well as meta-analysis of case studies. The assessment methods often include guidelines to recognize and balance biases in representations of the case studies through the expert knowledge of the assessment teams. Moreover, attempts are also made to achieve a balanced geographical, disciplinary and gender representations in the membership of the assessment teams in order to reduce the level of biases during the assessment, and prevent outcomes such as illustrated in Figure 3.

Along with global studies, what should also be encouraged are local studies that are explicit components of global studies, e.g., catch reconstruction (or their updates) of countries or national economic or climate studies that are explicit components of global catch reconstructions, climate or economic analyses aimed at apprehending the true marine fisheries catch or some economic or climate-related indicators of the world ocean, and their trends. However, isolated local studies published without a framework that allows generalization to the world oceans (or to all maritime countries) using one of the approaches listed above, even if of intrinsic interest, and potentially generalizable, should not be considered ‘global studies.’

We argue that encouraging truly global studies of fisheries related activities will contribute to a better understanding of the problems that besets our oceans, and of those whose livelihoods depend on fisheries, and assist in identifying solutions that are generous in the sense that they potentially apply to all people, wherever they are.

## References

- Campbell, B. and D. Pauly. 2013. Mariculture: A global analysis of production trends since 1950. *Marine Policy*, 39: 94-100.
- Cheung, W.W.L., V.W.Y. Lam, J.L. Sarmiento, K. Kearney, R. Watson, D. Zeller and D. Pauly. 2010. Large-scale redistribution of maximum fisheries catch potential in the global ocean under climate change. *Global Change Biology*, 16: 24-35.
- Cheung, W.W.L., J.L. Sarmiento, J. Dunne, T.L. Frölicher, V. Lam, M.L.D. Palomares, R. Watson and D. Pauly. 2013. Shrinking of fishes exacerbates impacts of global ocean changes on marine ecosystems. *Nature Climate Change*, 3: 254-258.
- Cheung W.W.L., M.C. Jones, V.W. Lam, D. Miller, Y. Ota, L. Teh and U.R. Sumaila 2017. Transform high seas management to build climate resilience in marine seafood supply. *Fish and Fisheries*, 18(2): 254–263.
- Cisneros-Montemayor, A.M. and U.R. Sumaila. 2010. A global estimate of benefits from ecosystem-based marine recreation: potential impacts and implications for management. *Journal of Bioeconomics*, 12(3): 245-268.
- Edwards, P.N. 2010. *A Vast Machine: Computer Models, Climate Data, and the Politics of Global Warming*. MIT Press, Cambridge, Mass.
- FAO, 2014. *The State of World Fisheries and Aquaculture 2014: Opportunities and challenges*. Food and Agriculture Organization of the United Nations, Rome.
- Garibaldi, L. 2012. The FAO global capture production database: A six-decade effort to catch the trend. *Marine Policy*, 36: 760-768.
- Lieth, H. 1973. Primary production: terrestrial ecosystems. *Human Ecology*, 1(4): 303-332.
- Lam, V.W.L., Cheung, W.W.L. Reygondeau, G., and Sumaila, U.R. (2016). Projected change in global fisheries revenues under climate change. *Scientific Reports* 6:32607.
- McNett, C.W. and R.E.Kirk. 1968. Drawing random samples in cross-cultural studies: a suggested method. *American Anthropologist*, 70(1): 50-55.
- Pauly, D. and D. Zeller. 2016. Catch reconstructions reveal that global marine fisheries catches are higher than reported and declining. *Nature Communications*, doi: 10.1038/ncomms10244, 9 p.
- Pauly, D., D. Belhabib, R. Blomeyer, W.W.L. Cheung, A. Cisneros-Montemayor, D. Copeland, S. Harper, V.W.Y. Lam, Y. Mai, F. Le Manach, H. Österblom, K.M. Mok, L. van der Meer, A. Sanz, Antonio, S. Shon, U.R.



- Sumaila, W. Swartz, R. Watson, Y. Zhai, and D. Zeller. 2014. China's distant-water fisheries in the 21st century. *Fish and Fisheries*, 15: 474-488.
- Sumaila, U.R., A. Khan, A.J. Dyck, R. Watson, G. Munro, P. Tyedmers and D. Pauly. 2010. A bottom-up re-estimation of global fisheries subsidies. *Journal of Bioeconomics*, 12: 201–225.
- Sumaila, U.R. V.W.Y. Lam, D. Miller, L. Teh, R.Watson, D. Zeller, W.W.L. Cheung, I. Côté, A. Rogers, C. Roberts, E. Sala and D. Pauly. 2015. Winners and losers in a world where the high seas is closed to fishing. *Scientific Reports*, 5: 8481, doi: 10.1038/srep08481.
- Sumaila, U.R., V. Lam, F. Le Manach, W. Swartz and D. Pauly. 2016. Global fisheries subsidies: an updated estimate. *Marine Policy*, 69, 189-193.
- Sverdrup, H.U., M.W. Johnson and R H. Fleming. 1942. *The Ocean*. Prentice-Hall, Englewood Cliffs, 1087 p.
- Swartz, W., E. Sala, R. Watson and D. Pauly. 2010. The spatial expansion and ecological footprint of fisheries (1950 to present). *PLoS ONE*, 5(12) e15143, 6 p.
- Tremblay-Boyer, L., D. Gascuel, R. Watson, V. Christensen and D. Pauly. 2011. Modelling the effects of fishing on the biomass of the world's oceans from 1950 to 2006. *Marine Ecology Progress Series*, 442: 169-185.
- Ward, M. 2004. *Quantifying the World: UN Ideas and Statistics*. United Nations intellectual history project series. Indiana University Press, Bloomington and Indianapolis. 329 p.
- Worm, B., R. Hilborn, J.K. Baum, T.A. Branch, J.S. Collie, C. Costello, M.J. Fogarty, E.A. Fulton, J.A. Hutchings, S. Jennings, O.P. Jensen, H.K. Lotze, P.M. Mace, T.R. McClanahan, C. Minto, S.R. Palumbi, A.M. Parma, D. Ricard, A.A. Rosenberg, R. Watson, and D. Zeller, D. 2009. Rebuilding global fisheries. *Science*, 325(5940): 578-585.

# THE COVERAGE OF ILLEGAL FISHING IN TURKISH NEWSPAPERS\*

Çetin Keskin and Yelda Aktan Turan

Fisheries Faculty, Ordu St. No: 200, 34470 laleli, İstanbul, Turkey

## Abstract

The coverage of alleged illegal fishing by foreign fishers in Turkish waters and by Turkish fishers in the waters of neighbouring countries by three Turkish daily (*Cumhuriyet*, *Milliyet* and *Hürriyet*) for the years 2000 to 2016 was studied. In total, 373 articles were identified and classified by subject matter with emphasis on types of alleged illegal activities and the countries involved.

## Introduction

Illegal, Unreported and Unregulated (IUU) fishing activities are globally serious threats to sustainable fishing (Pauly 2017). The elimination IUU fishing is possible through efficient and responsible domestic management measures, and international agreements protecting marine ecosystems. An example of significant regional progress is the recent European Union's Ministerial Declaration, which includes combating Illegal, Unreported and Unregulated fishing in the Mediterranean Sea and the Black Sea by 2020. Notably, the declaration aims to strengthen the governance of fisheries to increase their environmental and socio-economic sustainability (Anon 2017).

The Turkish EEZ along the Black Sea and the Sea of Marmara are predominantly commercial fishing areas where the targeted species are mainly anchovy (*Engraulis encrasicolus*) and highly migratory species, Atlantic bonito (*Sarda sarda*) and blue fish (*Pomatomus saltatrix*). Other major fisheries target turbot (*Scophthalmus maximus*) and Rapa whelk (*Rapana venosa*) which recently invaded the Black Sea.

These fisheries, along with other Turkish fisheries, suffer from inadequate management, and widespread resource depletions have occurred (Ulman and Pauly 2016). However, public awareness of this issues is limited, particularly with regards to illegal fishing, which is practiced both by foreign fishers operating in Turkish waters, and by Turkish fishers operating in the waters of neighbouring countries. This, study, therefore, is devoted to demonstrating the occurrence of illegal fishing, and its representation in the Turkish newspapers.

## Material and Method

To assess the media coverage of illegal fishing in Turkey, the archives of three Turkish daily newspapers, *Cumhuriyet*, *Milliyet*, and *Hürriyet* (Figure 1) representing much of the political spectrum in the country, were scanned and the titles of all articles dealing with marine fisheries were recorded back to the year 2000.



**Figure 1.** A newsstand in Istanbul, showing the three daily Turkish newspapers (*Cumhuriyet*, *Milliyet* and *Hürriyet*), whose coverage of fisheries was analyzed here, based on their archives from 2000 to 2016 (Photo by Çetin Keskin).

\* Cite as Keskin, C. and Aktan Turan (2018) "The coverage of illegal fishing in Turkish newspapers," Pp. 38-39. In Pauly D. and V. Ruiz-Leotaud (eds.) Marine and Freshwater Miscellanea. Fisheries Centre Research Reports 26(2). Institute for the Oceans and Fisheries, University of British Columbia.

## Results

A total of 373 articles were found relating to fisheries, including illegal operations by fishing vessel, operating outside of open fishing seasons or areas, targeting undersized fish or protected species, use of dynamite, and other issues (aquaculture, management, fishing regulation, protection, overfishing, human health, pollution, science, and entertainments) (Figure 2A).

Articles about alleged Turkish illegal activities in Turkish water referred mostly to trawl and/or purse seine fisheries in closed area and/or season (Figure 2B). Greece was the only foreign country mentioned (in 43 articles) about alleged illegal fishing in Turkish waters, mainly because in the Aegean Sea, the Exclusive Economic Zone (EEZ) of the two countries is not delimited.

Notably, one area, the waters around the Kardak Islands has seen numerous conflicts since 1996, mainly because of a local stock of gilthead seabream (*Sparus aurata*; *Çupra* or *Çipura* in Turkish) occurs around the islands every year in the months December and January. The annual fishing activities are regular opportunity to claim sovereignty, a process referred to “*Çupra dalaşı*” (‘political dogfights’) in the Turkish press.

On the other hand, alleged illegal fishing activities by Turkish fishers in foreign waters are reported mainly from the Black Sea (Figure 2C), and the target species is turbot in the Ukrainian, Romanian, and Bulgarian EEZs. Illegal fishing for anchovy was also reported from Georgian waters. In the Mediterranean, only one country was mentioned, with Turkish fisheries reportedly targeting bluefin tuna (*Thunnus thynnus*) in Algerian waters.

Even though IUU fishing in the Turkish part of the Black Sea shows a decreasing trend in recent years (Öztürk 2013), fisheries associations, cooperatives, initiatives, and public awareness will continue to play important roles for the successful control and management of the fisheries. Our results showed that fisheries issues get little coverage in the three newspapers analysed here, in the Turkish press, suggesting a limited role for fisheries in the Turkish press and presumably, among the Turkish public.

## Acknowledgements

Our thanks are due to Andrew M Lemieux and Kees Camphuysen for inviting one of us (Ç.K.) to present the poster upon which this contribution is based at the conference on “Globalization of Fisheries: the prevalence, actors, ecological impact and regulation of illegal fishing,” February 3-5, 2017, Texel, The Netherlands.

## References

- Anonymous. 2017. European Union Ministerial Conference on the Sustainability of Mediterranean Fisheries Malta, 30 March 2017, Malta.
- Öztürk, B. 2013. Some remarks of Illegal, Unreported and Unregulated (IUU) fishing in Turkish part of the Black Sea. *J. Black Sea/Mediterranean Environment*, 19(2): 256-267.
- Pauly, D. 2017. Illegal fishing by another name smells too sweet. *Oceana Magazine*, Spring 2017, p. 21.
- Ulman, A. and D. Pauly. 2016. Making history count: the shifting baselines of Turkish fisheries. *Fisheries Research*, 183: 74-79.

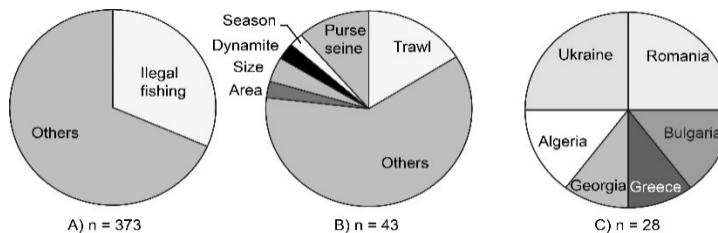

**Figure 2.** Results of the analysis of marine fisheries articles in the Turkish press, 2000 to 2016. **A:** Articles on fisheries in general vs. articles on alleged illegal fishing; **B:** Alleged illegal activities by Turkish fishers in Turkish waters, by gear; **C:** Alleged illegal entry of Turkish fishers in foreign waters.



## A NOTE ON URSIN'S FORMULAE FOR THE ESTIMATION OF NATURAL MORTALITY IN FISH STOCKS\*

Daniel Pauly

*Sea Around Us, Institute for the Oceans and Fisheries, 2202 Main Mall, University of British Columbia,  
Vancouver, Canada  
[d.pauly@oceans.ubc.ca](mailto:d.pauly@oceans.ubc.ca)*

### Abstract

This contribution, originally drafted in 1978, while the author was working on what later became “Pauly’s M-equation,” deals with spurious correlations, an ever-present danger in fisheries research and the biological sciences.

### Introduction

The present note is a by-product of a study of the interrelationships between growth parameters and natural mortality coefficients in various fish stocks (Pauly 1978).

The growth parameters used here are  $L_\infty$ ,  $W_\infty$  and  $K$  of the von Bertalanffy Growth Formula (VBGF) which has the form

$$L_t = L_\infty(1 - e^{-K(t-t_0)}) \text{ for length, and} \quad \dots 1)$$

$$W_t = W_\infty(1 - e^{-K(t-t_0)})^3 \text{ for weight.} \quad \dots 2)$$

Ursin (1967) attempted to demonstrate the existence of a relationship between size and natural mortality in fishes, using natural mortality estimates and size estimates selected from Table I in Beverton & Holt (1959). The plot of  $M$  against  $\log “W”_\infty$  in his Appendix Fig. 12 (p. 2433) indeed suggests the existence of such a relationship. From this plot and subsequent computations, Ursin (1967) derived two rules of thumb for the estimation of mortality, namely:

- i) “for species of the size order  $W = 10^3$  g, we have  $M = W^{-1/3}$ ” and
- ii) “when the weight is multiplied by 10 the natural mortality is halved.”

For reasons to be discussed elsewhere, the parameter  $K$  of the VBGF is referred to as “stress factor.” Also, the word “size” (abbreviated  $S$ ) will be used here instead of  $L_\infty$  and/or  $W_\infty$  wherever possible. Both rules of thumb have been used since by several authors.

No attempt will be made here to deal with the theoretical basis for the derivation of these rules of thumb. It appears, however, that they both provide quite inaccurate estimates of  $M$  when applied to any fish stocks outside of temperate waters, because there is no *direct* relationship between  $M$  and size in the data used by Ursin (1967) for the derivation of his rules. This is demonstrated in this note.

---

\* Cite as Pauly, D (2018) “A note on Ursin’s formulae for the estimation of natural mortality in fish stocks,” Pp. 40-43. In Pauly D. and V. Ruiz-Leotaud (eds.) Marine and Freshwater Miscellanea. Fisheries Centre Research Reports 26(2). Institute for the Oceans and Fisheries, University of British Columbia.

## Material and Methods

The  $L_{\infty}$ , K and M data selected from Beverton & Holt (1959) by Ursin (1967) are given here in Table I. Note that Ursin (1967) used for the conversion from length to weight the same condition factor (0.9) for all fishes.

The correlation coefficients between  $\log L_{\infty}$ ,  $\log W_{\infty}$ ,  $\log K$  and  $\log M$  are given in Table IIA. All are highly significant, thus seemingly demonstrating the existence of a relationship, among other things, between  $\log M$  and  $\log W_{\infty}$ . The relationship between  $\log M$  and  $\log K$ , however, is even closer, and it would therefore seem to be of interest to investigate what becomes of the relationship between  $\log M$  and  $\log W_{\infty}$  after the effect of  $\log K$  has been removed.

This can be investigated by calculating the partial correlation coefficient, that is, the correlation coefficient expressing the degree of association between two variables after the effect of a third variable has been eliminated. Interesting partial correlation coefficients between the variables S, K and M would be, in our case  $r_{KM,S}$ , which expresses the degree of association between  $\log K$  and  $\log M$  after the effect of  $\log S$  has been removed, and  $r_{SM,K}$ , which expresses the degree of association between  $\log S$  and  $\log M$  after the effect of  $\log K$  has been removed.

Table. I. Data of Beverton and Holt (1959), as used by Ursin (1967, Appendix, Table VII, p. 2431).

No.	Species	$L_{\infty}$ (cm)	"W" <sub>∞</sub>	K (year <sup>-1</sup> )	M (year <sup>-1</sup> )
1	<i>Clupea harengus</i>	30.	243.	0.38	0.25
2	<i>Clupea harengus</i>	21.	82.3	0.65	0.78
3	<i>Clupea pallasii</i>	23.	111.	0.29	0.56
4	<i>Sardinops caerulea</i>	26.	158.	0.39	0.15
5	<i>Gadus morhua</i>	132.	20700.	0.2	0.2
6	<i>Gadus minutus</i> ♂	20.	72.	0.42	1.1
7	<i>Gadus minutus</i> ♀	24.	124.	0.40	0.9
8	<i>Gadus virens</i>	107.	11025.	0.19	0.15
9	<i>Merluccius merluccius</i> ♂	44.	767.	0.13	0.6
10	<i>Merluccius merluccius</i> ♀	60.	1944.	0.10	0.5
11	<i>Pleuronectes platessa</i> ♂	45.	820.	0.15	0.22
12	<i>Pleuronectes platessa</i> ♀	70.	3087.	0.08	0.12
13	<i>P. americanus</i> <sup>a)</sup>	44.	767.	0.4	0.3
14	<i>Solea vulgaris</i>	39.	534.	0.4	0.25
15	<i>Acipenser fulvescens</i>	178.	50758.	0.05	0.01
16	<i>Acipenser</i> spp. <sup>b)</sup>	300.	243000.	0.06	0.03
17	<i>Blennius pholis</i>	17.	44.2.	0.30	0.9
18	<i>Callionymus lyra</i> ♂	25.	141.	0.43	0.96
19	<i>Callionymus lyra</i> ♀	17.5	48.2	0.55	0.86
20	<i>Cottus gobio</i> ♂	7.2	3.36	0.7	1.1
21	<i>Cottus gobio</i> ♀	7.3	3.50	0.4	0.9
22	<i>Cottus gobio</i> ♂	6.5	2.47	0.90	0.90
23	<i>Cottus gobio</i> ♀	6.5	2.47	0.50	0.80
24	<i>Phoxinus phoxinus</i>	9.	6.46	0.55	1.1
25	<i>Gasterosteus aculeatus</i>	6.7	2.71	0.64	0.9
26	<i>Pungitius pungitius</i>	4.3	0.72	1.6 <sup>c)</sup>	1.1
27	<i>Cynoscion macdonaldi</i>	128.	18874.	0.3	0.3
28	<i>Perca fluviatilis</i>	30.	243.	0.20	0.29
29	<i>Perca fluviatilis</i>	34.	354.	0.13	0.16
30	<i>Stizostedion canadensis</i>	40.	576.	0.14	0.44
31	<i>Dasyatis akajei</i> ♀	150.	30375.	0.1	0.45 <sup>d)</sup>
32	<i>Pneumatophorus diego</i>	40.	576.	0.4	0.9
33	<i>Neothunnus macropterus</i>	190.	61731.	0.5	0.8

- a) *P* = *Pseudopleuronectes*;  
 b) *Acipenser medirostris* and *A. transmontanus*;  
 c) 1.94 in Ursin (1967);  
 d) 0.4 in Ursin (1967).

Table II A. Correlation coefficients

Two-variable	Coefficients	Partial correlation	Coefficients
$r_{SK}$	-0.748	$r_{KM.S}$	0.488
$r_{KM}$	0.745	$r_{SM.K}$	-0.270*
$r_{SM}$	-0.677		

\* $r_{SM.K}$  not significant at 95% ( $r_{SM.K}$  Critical value = 0.349)

## Results and Discussion

The formulae for computing partial correlations are:

$$r_{KM.S} = \frac{r_{SK} - r_{SM}r_{KM}}{\sqrt{(1-r_{SM}^2)(1-r_{KM}^2)}} = 0.488 \quad \dots 3)$$

and

$$r_{SM.K} = \frac{r_{SM} - r_{SK}r_{KM}}{\sqrt{(1-r_{SK}^2)(1-r_{KM}^2)}} = -0.270 \quad \dots 4)$$

where, with thirty (30) degrees of freedom ( $n - 3$ ),  $r_{KM.S}$  is significant at the 99% level, while  $r_{SM.K}$  is not significant. (Table II A). This lack of relationship between logM and logS can also be shown when plotting logM against logS and logK in a multiple regression of the form:

$$\log M = a + b \log S + c \log K \quad \dots 5)$$

The parameter values obtained for both logM plotted against  $\log L_{\infty}$ , logK and for logM against  $\log "W"_{\infty}$ , logK are given in Table II B. While the multiple correlation coefficient ( $R = 0.766$  in both cases) is highly significant, it appears that the value of  $b$ , that is, the slope linking size with natural mortality, is not significantly  $\neq 0$  (Table II B). What we have here is the fact that the stress factor K affects both S and M and that, therefore, a direct link between S and M is suggested which in fact does not exist – or at least cannot be demonstrated solely on the basis of the data in Table I.

This note does not aim at disproving the existence in fishes of a direct relationship between natural mortality and size. Indeed, such a relationship does exist, as can be demonstrated by using a larger body of empirical mortality and size data, and by eliminating the effects of associated values of K and of environmental temperature (Pauly 1978).

The point here is that the relationships proposed by Ursin (1967) are misleading because they directly related M and size, although the data at hand (Table I) shows that, in fact, there is a direct relationship only between M and K, the apparent relationship between M and size being due to the effect of K on size. The results, in this case, are that the real effect of size on mortality – which is quite small (see Pauly 1978) – becomes overestimated, and that

Table II B. Multiple Regression of M on S and K.

$$\log M = 0.3940 - 0.2632 \log L_{\infty} + 0.7248 \log K$$

$$\log M = 0.2145 - 0.0873 \log "W"_{\infty} + 0.7247 \log K$$

Equations 6 and 7: Critical value (99%):  $R = 0.766$  0.514. DF = 30, N = 33.

Standard deviation for log estimates of M = 0.3107.  
 95% confidence intervals for partial regression coefficients:  
 Equation 6)  $b = -0.2632 \pm 0.3538$ ;  $c = 0.7248 \pm 0.4848$   
 Equation 7)  $b = -0.0878 \pm 0.1170$ ;  $c = 0.7248 \pm 0.4848$

the proposed rules of thumb become grossly inaccurate in fishes with high values of K, for example, in tropical fishes.

Sachs (1974, p. 352-353) gives a discussion of an analogous case, in the field of medicine, where an assumed relationship between varicose veins and other circulatory disorders was long assumed, because their correlated occurrence had led early authors to assume the existence of a “*status varicosus*.” This was demonstrated by Wagner (1955) to be an artifice caused by the direct relationships between age and varicose veins on the one hand, and age and other circulatory disorders on the other.

## References

- Beverton, R.J.H., and S.J. Holt. 1959. A review of the lifespans and mortality rates of fish in nature, and their relation to growth and other physiological characteristics. *Ciba Found. Coll. Ageing*. 5: 142-180.
- Pauly, D. 1978. A discussion of the potential use in population dynamics of the interrelationships between natural mortality, growth parameters and mean environmental temperature in 122 fish stocks. I.C.E.S. C.M. 1978/G:21: 36 p. [see also Pauly, D. 1980. On the interrelationships between natural mortality, growth parameters and mean environmental temperature in 175 fish stocks. *J. Cons. int. Explor. Mer* 39(3): 175-192].
- Sachs, L. 1974. *Angewandte Statistik*. Springer Verlag, Berlin, 545 p.
- Ursin, E. 1967. A mathematical model of some aspects of fish growth, respiration, and mortality. *J. Fish. Res. Bd. Canada*. 24(11): 2355 -2453.
- Wagner, G. 1955. Zur Methodik des Vergleichs altersabhängiger Dermatosen. (Zugleich korrelationsstatistische Kritik am sogenannten “*Status varicosus*”). *Zschr.menschl. Vererb.-Konstit.-Lehre*. 53: 550-578.

## ESTIMATION OF GLOBAL MEIOFAUNA AND MACROFAUNA BIOMASS\*

Aja Szumylo<sup>1</sup> and Daniel Pauly<sup>2</sup>

1) Marine Conservation Biology Institute 2122 112th Ave NE, Suite B-300 Bellevue WA 98004 USA  
Currently: US National Marine Fisheries Service

2) Sea Around Us, Institute for the Oceans and Fisheries, 2202 Main Mall, University of British Columbia, Vancouver, Canada  
[d.pauly@oceans.ubc.ca](mailto:d.pauly@oceans.ubc.ca)

### Abstract

Global distribution models of benthic biomass were generated for meiobenthos (0.1-1 mm) and macrobenthos (1 mm - 1 cm) based on general linear models linking benthos biomass with depth, sea surface and bottom temperature, and surface chlorophyll-*a*. The source of the data points (n=184 and n=140, respectively), and environmental variables used for the calculations are presented, along with the most important sources of uncertainty. The models for meiofauna and macrofauna accounted for 27% and 42% of the variation in measured biomass values, respectively (p < 0.0001). The model predicts a total of 2.34 x 10<sup>9</sup> teragrams of meiofauna biomass and 1.07 x 10<sup>7</sup> teragrams macrofauna biomass across the world ocean for an estimated total of 1.3 x 10<sup>10</sup> teragrams benthic invertebrate meiofauna and macrofauna biomass worldwide. This study, performed about 12 years ago, but not published then, yielded result roughly similar to the more detailed contribution by Wei *et al.* (2010, PLoS ONE 5(12): e 15323; doi: 10:1371/journal.pone.0015323), though it is based on far less input data and variables.

### Introduction

Invertebrate species buried in or living on the sea bottom and jointly forming the benthos occur in all oceans. Understanding the spatial distribution of benthic invertebrate biomass can provide valuable information about regional variability in biogeochemical processes (Marcus 1998; Wei *et al.* 2010), and allow for the more complete construction of mass-balance models of oceanic systems (Vasconcellos 2004). Estimates of benthic biomass can also serve as a time averaged proxy for the flux of carbon to the deep ocean (Rex *et al.* 2006). The continental shelves, which receive organic input from terrestrial sources, and upwelling regions are considered to have the greatest abundance of benthic biomass, but primary production from chemoautotrophic bacteria in communities at great depths surrounding cold seeps (Gatehouse 1998) and hydrothermal vent (Van Dover 2000) can also support high levels of biomass.

In general, with increasing distance from land, benthic communities, especially those in the deep sea, depend on a small amount of organic input from animal and plant remains and marine snow—macroscopic aggregations of detritus, inorganic matter and living organisms that fall to the ocean floor from the euphotic zone (Alldredge and Silver 1988). While it is widely accepted that benthic biomass for all size classes falls steadily with depth (Rowe 1984; Thiel 1975), spatial variation in a variety of physical, chemical and biological factors may also play a significant role in determining biomass distribution and abundance (Gooday and Turley 1990; Galeron *et al.* 2000).

The input of organic matter varies temporally and spatially throughout the world's oceans. Miller (2004) credits greater benthic biomass in high latitudes to seasonal blooms in primary productivity. Unlike higher latitudes, primary production at low latitudes is utilized year-round by pelagic communities, which reduces food availability for benthic communities. Lateral transfer by currents at the surface and at depth is important in the distribution of organic material (Kroncke 2000; Soltwedel 1997). Additional biotic and abiotic factors, such as nutrient (silicate, nitrate, phosphate) and oxygen availability, local sedimentation and substrate composition

\* Cite as Szumylo, A. and Pauly, D. (2018) "Estimation of Global Meiofauna and Macrofauna Biomass," Pp. 44-52. In Pauly D. and V. Ruiz-Leotaud (eds.) Marine and Freshwater Miscellanea. Fisheries Centre Research Reports 26(2). Institute for the Oceans and Fisheries, University of British Columbia.

(Lovell and Trengo 2003) and inter- and intra- species interaction may also influence the spatial distribution of benthic biomass (Alongi 1992).

The spatial variation of the biotic and abiotic environmental characteristics outlined above suggests that the accepted assumption that benthic biomass decreases with depth may not be valid for some regions of the world's oceans and that prediction of biomass distribution must take these variables into account. While benthic biomass measurements have been recorded for all ocean basins, the vast majority of measurements have been taken in the Atlantic and Arctic Oceans by long-established European and American oceanographic institutions (Rex 2006). The scarcity of measurements from the Indian, Pacific, and Southern Oceans, makes modeling benthic biomass for these regions difficult. Further, a number of the factors speculated to be important in influencing benthic biomass distribution are complicated, if not impossible, to estimate on any scale.

Because of these factors, global accounts of benthos distribution are rare (see Rex *et al.*, 2006), and no estimation exists that attempts to deal simultaneously with the major factors affecting benthos distribution for the world ocean. This contribution represents such an attempt, and is based on multivariate analysis of two datasets summarizing biomass measurements for meiobenthos and macrobenthos combined with GIS mapping.

Our aim is not to replace measurements for site-specific purposes, such as environmental impact assessment, but to produce broadly patterned global maps, thereby fulfilling three goals:

- 1) Providing a global benchmark for benthic biomass, enabling comparisons of local studies, i.e. providing a standard for low or high biomasses;
- 2) Providing a first estimate of benthic biomass for large-scale trophic models of ecosystems;
- 3) Providing the first step of an exercise to identify additional factors impacting the distribution of benthos on a global scale.

## Methods

### Data Used

Table 1 summarizes the key features of the two datasets assembled here from 28 publications which reported to geographic coordinates for their benthos biomass measurements (listed with location and size class in References; see also Figure 1). As in Rex *et al.* (2006), taxonomic groups of marine benthic invertebrates are segregated by size in this study. Metazoan meiofauna, invertebrate groups retained on sieves of 30 to 74  $\mu\text{m}$  mesh size, include foraminiferans, nematodes, harpacticoid copepods among others. Metazoan macrofauna included those organisms retained on sieves between 250 and 1000  $\mu\text{m}$  mesh size such as polychaete worms, crustaceans and mollusks. Because of the limited number of publications presenting samples of metazoan megafauna, which comprises cnidarians, crustaceans and echinoderms visible on the sediment, global estimates for this size class are not presented in this analysis. Figure 1 shows the geographic distribution of observed data points for meiofauna and macrofauna.

<b>Table 1.</b> Size classes used to categorize benthos, associated mesh sizes and number of cases available for the empirical equations. The data originated from peer-reviewed journal articles published between 1962 and 1998).			
<b>Class</b>	<b>Size</b>	<b>Lower sieve mesh size (<math>\mu\text{m}</math>)</b>	<b>Number of data points</b>
Meiofauna	0.1-1 mm	30 – 74	184
Macrofauna	1 mm – 1 cm	250 – 1000	140

The spatial and temporal resolution for environmental parameters used to estimate global distribution of benthic meiofauna and macrofauna biomass are summarized in Table 2. ETOPO2 bathymetry data were obtained from the National Oceanic and Atmospheric Administration's (NOAA) National Geophysical Data Center (NGDC). This dataset was constructed by combining available depth soundings with high-resolution marine gravity information from the Geosat and ERS-1 spacecraft. Spatial resolution of ETOPO2 bathymetry is 2-minute (13.7 km<sup>2</sup> at the equator) (Smith and Sandwell, 1997).



**Table 2.** Spatial and temporal scale of environmental variables used to estimate benthic biomass distribution and abundance. Meiofauna and macrofauna range refer to the minimum and maximum value for each environmental variable that occurs for all observed data points, as used to generate the global estimate presented here.

<b>Environmental variable (unit); source</b>	<b>Spatial</b>	<b>Temporal</b>	<b>Meiofauna range</b>	<b>Macrofauna range</b>
<b>Bathymetry (m);</b> Smith and Sandwell (1997)	2 min.	None	3 - 8232	2 - 5721
<b>Sea Surface Temperature (°C);</b> NASA/GSFC MODIS; Feldman (2006)	4.7 km	Annual mean (2002-2005)	-0.98 - 28.7	-0.98 - 28.7°
<b>Bottom temperature (°C);</b> 2001 World Ocean Atlas; Conkright (2002)	1 °C	Annual mean	-0.81 - 27.8	-1.9 - 27.3
<b>Bottom salinity (PSU);</b> 2001 World Ocean Atlas; Conkright (2002)	1 deg	Annual mean	32.8 - 38.9	33.5 - 35.8
<b>Surface Chlorophyll-<i>a</i> concentration (m·mg<sup>3</sup>);</b> NASA/GSFC MODIS; Feldman (2006)	4.7 km	Annual mean (2002-2005)	0.06 - 17.4	0.07 to 17.4
<b>Nutrients (μmol L<sup>-1</sup>);</b> 2001 World Ocean Atlas; Conkright (2002)	1 deg	Annual mean	--	--
<b>Bottom silicate</b>	--	--	1.5 - 150.4	2.4 - 154.3
<b>Bottom phosphate</b>	--	--	0.09 - 2.7	0.22 - 0 3.2
<b>Bottom nitrate</b>	--		0.13 - 37.1	0.36 - 44.2
<b>Bottom oxygen;</b> 2001 World Ocean Atlas; Conkright (2002)	1 deg	Annual mean	--	--
<b>Apparent oxygen utilization (mL·L<sup>-1</sup>)</b>			-0.41 - 4.9	-0.23 - 6.5
<b>Dissolved Oxygen (mL·L<sup>-1</sup>)</b>			1.4 7.4	0.26 - 7.4
<b>Oxygen saturation (%)</b>			24.5 - 108.7	3.1 - 105.4

Bottom temperature, bottom salinity, bottom phosphate, bottom nitrate, bottom silicate, bottom dissolved oxygen, apparent bottom oxygen utilization (oxygen saturation concentration minus measured dissolved oxygen concentration), and percent bottom oxygen saturation (the amount of dissolved oxygen as a percentage of maximum potential oxygen amount that could be present for the given temperature and salinity at standard atmospheric pressure), are annual mean measurements of these variables (Conkright, 2002) taken at standard intervals down to 5500 meters. The native resolution of WOA01 data is 1-degree, but this was resampled by the Kansas Geological Survey (KGS) at ETOPO2 resolution and depth. There were several regions of the world's oceans that did not have values for these grids. These areas were interpolated by the KGS using the ESRI ArcGIS Nibble Algorithm, which replaces missing values with the value of the nearest neighbor.

Sea surface temperature and chlorophyll-*a* data were obtained from NASA's Goddard Space Flight Center. Both data sets were derived from the Moderate Resolution Imaging Spectroradiometer (MODIS), a key instrument aboard the Aqua Earth Observing System PM satellite (Feldman, 2006). Annual averaged grids from 2002 to 2005 were averaged together to produce a single composite grid. Spatial resolution was resampled from 4.7 km resolution to 2-minute resolution using ESRI's resampling algorithm.

Inconsistencies in the yearly average grids for sea surface temperature and chlorophyll-*a* were found for areas presumably covered by ice for a significant portion (more than six months) of the year. These areas not used in the analysis.

## Analyses

### Selection of environmental variables

We investigated seven variables for their relationship to benthic biomass. Depth, surface and bottom temperature and chlorophyll-*a* concentration were included to represent spatial variation in food availability. Other variables, such as bottom nutrient concentrations (silicate, nitrate and phosphate), salinity and several expressions of oxygen content were tested to determine if they might have an effect. The correlation matrices (Table 3) evaluate the degree of global covariation of the environmental variables. The strongest correlation was found between the bottom nutrient concentrations and the variants of bottom water oxygen content.

**Table 3.** Correlation matrix of variables for the data points associated with meiofauna (in gray) and macrofauna biomass samples (1: depth; 2: average annual sea surface temperature; 3: bottom temperature; 4: bottom salinity; 5: average annual chlorophyll-*a* concentration; 6A: bottom silicate; 6B: bottom phosphate; 6C: bottom nitrate; 7A: apparent bottom oxygen utilization; 7B: bottom dissolved oxygen; 7C: percent bottom oxygen saturation).

	1	2	3	4	5	6A	6B	6C	7A	7B	7C
1	-	0.208	0.457	0.235	0.078	0.600	0.500	0.495	0.324	0.095	0.206
2	-0.105	-	0.389	0.142	0.338	0.135	0.237	0.241	0.381	0.602	-0.431
3	0.356	0.509	-	0.564	0.249	0.404	-0.545	-0.565	-0.227	0.538	0.055
4	0.243	0.067	0.147	-	-0.141	-0.310	-0.595	-0.563	-0.261	-0.255	0.139
5	0.349	0.528	-0.375	0.152	-	0.030	0.025	0.012	0.045	0.264	0.084
6A	-0.451	0.401	0.043	0.006	0.067	-	0.763	0.711	0.618	0.204	0.486
6B	0.344	0.545	0.024	0.124	-0.123	0.876	-	0.976	0.846	0.292	-0.729
6C	0.407	0.480	0.066	0.185	0.082	0.882	0.977	-	0.861	-0.301	-0.749
7A	-0.259	0.506	0.115	0.204	-0.081	0.796	0.956	0.935	-	0.682	-0.973
7B	0.050	0.636	0.478	0.224	0.258	-0.676	0.845	-0.793	0.920	-	0.796
7C	0.181	-0.533	-0.201	0.232	0.118	-0.726	-0.925	0.894	0.990	0.948	-

### Modeling benthic biomass distribution

The ArcGIS sample algorithm was used to link values from the bathymetry, bottom temperature, sea surface temperature, chlorophyll-*a*, silicate, nitrate, phosphate and oxygen grids to the log biomass values associated with the points shown in Figure 1. Again, data points from areas that appeared to be covered in ice for a significant portion of the year were not included in the final analysis. Multiple linear regression analysis was performed in STATA™ to develop a model for predicting log meiofauna and macrofauna biomass using a number of combinations of environmental variables (Table 4). Because the addition of environmental variables

aside from those that proxy spatial variation in food availability did not significantly strengthen models across size classes, the final model chosen only included depth, surface and bottom temperature and chlorophyll-*a* concentration. The resulting regression equations were used with the variable grids to create an estimate of global benthic log biomass for each size class.

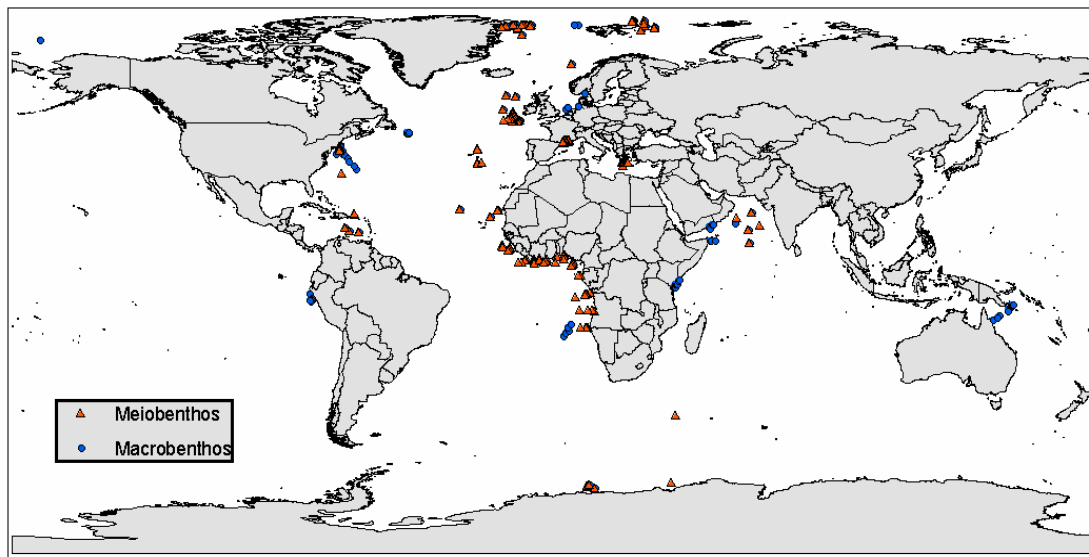

**Figure 1.** Global distribution of the sample benthos measurements used to estimate biomass abundance.

## Results and Discussion

Regression coefficients are shown in Table 5. The models for meiofauna and macrofauna accounted for 27% and 42% of the variation in measured biomass values, respectively ( $p < 0.0001$ ). Bathymetry and sea surface temperature had significant influence in both models ( $p < 0.05$ ), and bottom temperature had a significant influence on the macrofauna model ( $p < 0.01$ ). The resulting maps are shown in Figure 2, whose basic features are roughly similar to those in Figure 7 of Wei *et al.* (2010); the main difference between these maps is that mid-ocean ridges are prominent in Figure 2, if only because they are predicted to have the higher benthic biomass associated with their elevation (as also occurs in reality, see, e.g., Haymon *et al.* 1991 and Mortensen *et al.* 2008). In contrast, Figure 7 of Wei *et al.* (2010) shows no mid-ocean ridge effect.

Table 6 presents estimated total values of meio- and macrobenthos biomass summarized by ocean basin from maps presented in Figures 2a and 2b. The model predicts a total of  $2.34 \times 10^9$  teragrams of meiofauna biomass and  $1.07 \times 10^7$  teragrams macrofauna biomass across the world ocean for an estimated total of  $1.3 \times 10^{10}$  teragrams benthic invertebrate meiofauna and macrofauna biomass worldwide.

This study represents a method for predicting benthic biomass on the global scale using depth, temperature, and chlorophyll-*a* concentration. The maps derived from the regression analysis presented in Table 2 resemble bathymetric maps (Figure 2). This is to be expected, as depth has the most predominant effect on biomass distribution. While sampling coverage is limited (there was very little data available for the Pacific Ocean basin) and measurements of biomass used in this projection were recorded over a course of more than 30 years using a number of different collection, sorting and preservation methods (Gage *et al.*, 2002), the analysis presented here is a step towards quantifying the environmental variables that influence the distribution of benthic biomass between and within ocean basins.

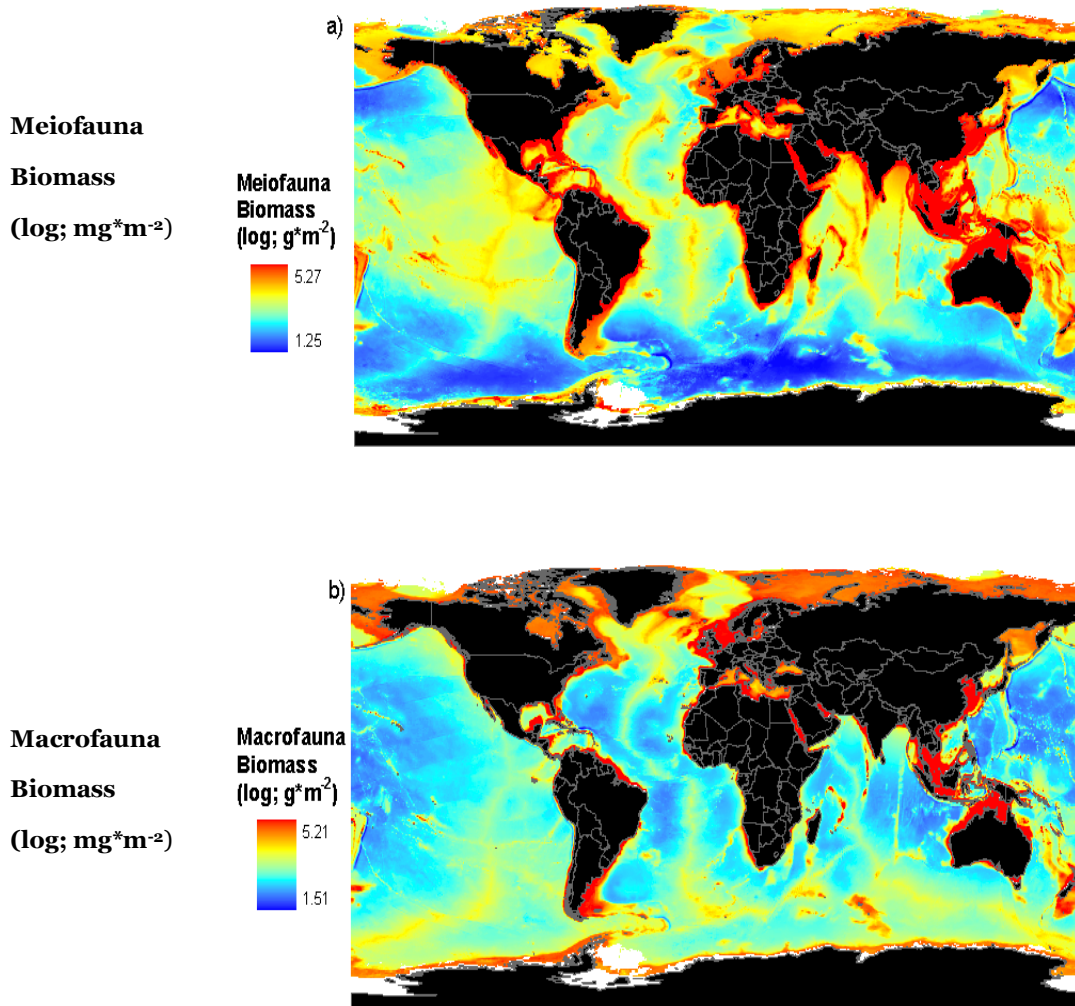

**Figure 2.** Maps detailing log benthic biomass for meiofauna (a) and macrofauna. White areas of the map are covered by ice for more than six months of the year.

Several additional considerations, experimental investigation of the importance of other environmental variables, the variable response of different taxa to food availability, physical oceanography and an expanded distribution of field measurements, should be taken into account in future permutations of this study. In investigating variations in benthic community structure and size class in the tropical North East Atlantic, Galeron *et al.* (2000) demonstrated that within a single geographic location, both different size class and different taxa within size classes responded differently to variations in food availability. This suggests that other environmental variables, such as those used in this analysis, may play a part in governing benthic biomass distribution.

Food availability has been shown to determine the relative abundance of benthic size classes in the Eurasian Arctic Ocean (Kroncke, 1998). The findings of Galeron *et al.* (2000) and Kroncke *et al.* (2000) suggest that in the presence of an abundant food supply, larger benthic organisms compete directly for organic material. On the other hand, in food-limited locations, smaller benthic organisms and bacteria convert organic matter into a form usable by higher trophic levels. Thus, the distribution and abundance of bacteria should also be considered in future models.

The investigation of ocean movement and physical disturbances may also be helpful in estimating biomass distribution. Kroncke *et al.* (2000) suggested that currents may actually assist in the lateral transport of organic material which may sustain life in areas with low food supply from the overlying waters. At greater velocities,

however, currents inhibit the growth of benthic communities by re-suspending sediment (Rhoads and Young, 1970). There may also be areas in polar regions where the contact of glacial ice with the ocean floor may prevent growth of benthic organisms.

Benthic biomass estimates of the Arctic and Antarctic were not included in this analysis because environmental data for these regions, specifically remotely sensed data for sea surface temperature and chlorophyll-*a* concentrations, were unavailable. Because the polar regions tend to have higher than average benthic biomass (Brey and Gerdes, 1997) and intermediate species richness (Piepenburg, 2005), improvements of sea surface temperature and chlorophyll-*a* grids generated from satellite imagery can be used to improve benthos biomass estimations.

## Acknowledgements

We express our thanks to Drs. Elliott Norse, John Guinotte and Lance Morgan of the Marine Conservation Biology Institute and Gilbert Rowe of Texas A&M University for their assistance in analysis of the data presented therein.

## References\*

- Allredge, A.L., Silver, M.W. (1988) Characteristics, dynamics and significance of marine snow. *Progress in Oceanography*, 20(1): 41-82.
- Alongi, D.M. 1992. Bathymetric patterns of deep-sea benthic communities from bathyal to abyssal depths in the western South Pacific (Solomon and Coral Seas). *Deep-Sea Research* 39: 549-565. **(SW Pacific, Macrofauna)**
- Brey, T., and Gerdes, D. (1997) Is Antarctic benthic biomass really higher than elsewhere? *Antarctic Science* 9(3): 266-267.
- Christiansen, B. W. Beckman, H. Weikert. 2001. The structure and carbon demand of the bathyal benthic boundary layer community: a comparison of two oceanic locations in the NE-Atlantic. *Deep Sea Research* 48: 2409-2424. **(NE Atlantic, Megafauna)**
- Clough, L.M., W.G. Ambrose, Jr., J.K. Cochran, C. Barnes, P.E. Renaud, R.C. Aller. 1997. Infaunal density, biomass and bioturbation in the sediments of the Arctic Ocean. *Deep Sea Research II* 44(8): 1683-1704. **(Arctic, Macrofauna)**
- Conkright, M.E., Locarnini, R.A., Garcia, H.E., O'Brien, T.D., Boyer, T.P., Stephens, C., Antonov, J.I. (2002). World Ocean Atlas 2001: Objective Analyses, Data Statistics, and Figures, CD-ROM Documentation. National Oceanographic Data Center, Silver Spring, MD, 17 p.
- Danovaro, R., N.D. Croce, A. Eleftheriou, M. Fabiano, N. Papadopoulou, C. Smith, A. Tselepides. 1995. Meiofauna of the deep Eastern Mediterranean Sea: distribution and abundance in relation to bacterial biomass, organic matter composition and other environmental factors. *Prog Oceanog* 36: 329-341. **(Mediterranean, Meiofauna)**
- Dauwe, B., P.M.J. Herman, C.H.R. Heip. 1998. Community structure and bioturbation potential of macrofauna at four North Sea stations with contrasting food supply. *Mar Ecol Prog Ser* 173: 67-83. **(North Sea, Macrofauna)**
- Duineveld, G.C.A., P.A.W.J. De Wilde, E.M. Berghuis, A. Kok, T. Tahey, J. Kromkamp. 1997. Benthic respiration and standing stock on two contrasting continental margins in the western Indian Ocean: the Yemen-Somali upwelling region and the margin off Kenya. *Deep-Sea Research II*, 44(6-7):1293-1317. **(Indian Ocean, Macrofauna)**
- Feldman, G.C., C.R. McClain, Ocean Color Web, SeaWIFS Reprocessing, NASA Goddard Space Flight Center. Eds. Kuring, N., Bailey, S. W. August 2006. <http://oceancolor.gsfc.nasa.gov>
- Frankenberg, D. R.J. Menzies. 1968. Some quantitative analyses of deep-sea benthos off Peru. *Deep-Sea Research* 15: 623-626. **(Tropical NE Pacific, Macrofauna)**
- Gage, J.D., Hughes, D.J., Gonzalez Vecino, J.L. (2002) Sieve size influence in estimating biomass, abundance and diversity in samples of deep-sea macrobenthos. *Mar Eco Prog Ser*, 225: 97 – 107.
- Galeron, J., M. Sibuet, M.-L. Mahaut, A. Dinet. 2000. Variation in structure and biomass of the benthic communities at three contrasting sites in the tropical Northeast Atlantic. *Mar Ecol Prog Ser* 197: 121-137. **(Tropical NE Atlantic, all size classes)**
- Gremare, A., L. Medernach, F. deBovee, J.M. Amouroux, G. Vetion, P. Albert. 2002. Relationships between sedimentary organics and benthic meiofauna on the continental shelf and the upper slope of the Gulf of Lions. *Mar Ecol Prog Ser* 234: 85-94. **(Mediterranean, Meiofauna)**

\* With region and type of benthic fauna in bold characters when appropriate.

- Gooday, A.J., Turley, C.M (1990) Responses by benthic organisms to inputs of organic material to the ocean floor: a review. *Phil. Trans. R. Soc. London*, 331: 119-138.
- Haedrich, R.L, Rowe, G.T. (1977) Megafaunal biomass in the deep sea. *Nature*, 269, 141-142.
- Haymon, R.M., D.J. Fornari, M.H. Edwards, S. Carbotte, D. Wright and K.C. Macdonald. 1991. Hydrothermal vent distribution along the East Pacific Rise crest (9°09'–54' N) and its relationship to magmatic and tectonic processes on fast-spreading mid-ocean ridges. *Earth and Planetary Science Letters* 104(2-4): 513-534.
- Heip, C.H.R., G. Duineveld, E. Flach, G. Graf, W. Helder, P.M.J. Herman, M. Laveleye, J.J. Middleburg, O. Pfannkuche, K. Soetaert, T. Soltwedel, H. de Stigter, L. Thomsen, J. Vanaverbeke, P. de Wilde. 2001. The role of benthic biota in sedimentary metabolism and sediment-water exchange processes in the Goban Spur area (NE Atlantic). *Deep-Sea Research II* 48: 3223-3243. **(NE Atlantic, all size classes)**
- Houston, K.A. and R.L. Haedrich. 1984. Abundance and biomass of macrobenthos in the vicinity of Carson Submarine Canyon, northwest Atlantic Ocean. *Marine Biology* 82: 301-305. **(NW Atlantic, Macrofauna)**
- Hughes, D.J., J.D. Gage. 2004. Benthic metazoan biomass, community structure and bioturbation at three contrasting deep-water sites on the northwest European continental margin. *Progress in Oceanography* 63: 29-55. **(NE Atlantic, all size classes)**
- Jensen, P., J. Rumohr, G. Graf. 1992. Sedimentological and biological differences across a deep-sea ridge exposed to advection and accumulation of fine-grained particles. *Oceanol. Acta* 15(3): 287-296. **(Norwegian Sea, Meiofauna and Macrofauna)**
- Kroncke, I. 1998. Macrofauna communities in the Amundsen Basin, at the Morris Jesup Rise and at the Yermak Plateau (Eurasian Arctic Ocean). *Polar Biology* 19: 383-392. **(Arctic, Macrofauna)**
- Kroncke, I., A. Vanreusel, M. Vincx, J. Wollenburg, A. Mackensen, G. Liebezeit, B. Behrends. 2000. Different benthic size-compartments and their relationship to sediment chemistry in the deep Eurasian Arctic Ocean. *Mar Ecol Prog Ser* 199: 31-41. **(Arctic, Meiofauna and Macrofauna)**
- Kroncke, I., M. Turkay. 2003. Structural and functional aspects of the benthic communities in the deep Angola Basin. *Mar Ecol Prog Ser* 260: 43-53. **(Tropical E/SE Atlantic, Macrofauna and Megafauna)**
- Lampadariou, N., A. Tselepidis. 2006. Spatial variability of meiofaunal communities at areas of contrasting depth and productivity in the Aegean Sea (NE Mediterranean). *Progress in Oceanography* 69: 19-36. **(Mediterranean, Meiofauna)**
- Laveleye, M.S.S., G.C.A. Duineveld, E.M. Berghius, A. Kok, R. Witbaard. 2002. A comparison between the megafauna communities on the N.W. Iberian and Celtic continental margins—effects of coastal upwelling? *Progress in Oceanography* 52: 459-476. **(NE Atlantic, Megafauna)**
- Lovell, L.L., K.D. Trego. 2003. The epibenthic megafaunal and benthic infaunal invertebrates of Port Foster, Deception Island. *Deep-Sea Research II* 50: 1779-1819. **(Antarctic, Megafauna)**
- Marcus, N.H., F. Boero. 1998. Minireview: The importance of benthic-pelagic coupling and the forgotten role of life cycles in coastal aquatic systems. *Limnology and Oceanography* 43(5): 763-768.
- Mortensen, P.B., L. Buhl-Mortensen, A.V. Gebruk and E.M. Krylova. 2008. Occurrence of deep-water corals on the Mid-Atlantic Ridge based on MAR-ECO data. *Deep Sea Research Part II: Topical Studies in Oceanography* 55(1-2):142-52.
- Parulekar, A.H., Z.A. Ansari, S.N. Harkantra. 1983. Benthic fauna of the Antarctic Ocean—Quantitative aspects. From the Scientific report of the first Indian Expedition to Antarctica. *DOD Tech. Publ.* 1: 213-218. **(Antarctic, Meiofauna and Macrofauna)**
- Pfannkuche, O. 1985. The deep-sea meiofauna of the Porcupine Seabight and abyssal plain (NE Atlantic): population structure, distribution and standing stocks. *Oceanol. Acta* 8(3): 343-353. **(NE Atlantic, Meiofauna)**
- Pfannkuche, O., H. Thiel. 1987. Meiobenthic and benthic activity on the NE-Svalbard Shelf and in the Nansen Basin. *Polar Biol* 7: 253-266. **(Arctic, Meiofauna and Macrofauna)**
- Piepenburg, D. 2005. Recent research on Arctic benthos: common notions need to be revised. *Polar Biology* 28: 733-755.
- Relexans, J.-C., J. Deming, A. Dinet, J.-F. Gaillard, M. Sibuet. 1996. Sedimentary organic matter and micro-meiobenthos with relation to trophic conditions in the tropical northeast Atlantic. *Deep-Sea Research I* 43(8): 1343-1368. **(NE Atlantic, Meiofauna)**
- Rex, M.A., Etter, R.J., Morris, J.S., Crouse, J., McClain, C.R., Johnson, N.A., Stuart, C.T., Deming, J.W., Thies, R., Avery, R. (2006) Global bathymetric patterns of standing stock and body size in the deep-sea benthos. *Marine Ecology Progress Series* 317: 1-8.
- Richardson, M.D., D.K. Young. 1987. Abyssal benthos of the Venezuela Basin, Caribbean Sea: standing stock considerations. *Deep Sea Research* 34: 145-164. **(Caribbean, all size classes)**



- Rowe, G.T., G.S. Boland, E.G.E. Briones, M.E. Cruz-Kaegi, A. Newton, D. Piepenburg, I. Walsh, J. Deming. 1997. Sediment community biomass and respiration in the Northeast Water Polynya Greenland: a numerical simulation of benthic lander and spade core data. *Journal of Mar Sys* 10: 497-515. **(Norwegian Sea, Meiofauna and Macrofauna)**
- Rhoades, D.C., Young, D.K. (1970) The influence of deposit-feeding organisms on sediment stability and community trophic structure. *J Mar Res* 28: 150 – 177.
- Rowe, G.T. (1984) Biomass and production of the deep-sea macrobenthos. In: Rowe, G.T., ed. *The Sea*, Vol. 8 Deep-Sea Biology. Wiley-Interscience, New York, 97-121.
- Sarda, F., J.E. Cartes, J.B. Company. 1994. Spatio-temporal variations in megabenthos abundance in three different habitats of the Catalan deep-sea (Western Mediterranean). *Marine Biology* 120: 211-219. **(Mediterranean, Megafauna)**
- Smith, Jr., K.L. 1978. Benthic community respiration in the N.W. Atlantic Ocean: in situ Measurements from 40 to 5200m. *Marine Biology* 47:337-347. **(NW Atlantic, Macrofauna)**
- Smith, W.H.F., Sandwell, D.T. (1997) Global Sea Floor Topography from Satellite Altimetry and Ship Depth Soundings. *Science*, 277: 1956 – 1962.
- Soltwedel, T. 1997. Meiobenthos distribution pattern in the tropical East Atlantic: indication for fractionated sedimentation of organic matter to the sea floor? *Marine Biology* 129: 747-756. **(Tropical E Atlantic, Meiofauna)**
- Sommer, S., O. Pfannkuche. 2000. Metazoan meiofauna of the deep Arabian Sea: standing stocks, size spectra and regional variability in relation to monsoon induced enhanced sedimentation regimes of particulate organic matter. *Deep-Sea Research II* 47: 2957-2977. **(Arabian Sea, Meiofauna)**
- Thiel, H. (1975) The size structure of the deep-sea benthos. *Int Rev Gesamten Hydrobiol* 60: 575 – 606.
- Thurston, M.H., A.L. Rice, B.J. Bett. 1998. Latitudinal variation in the invertebrate megafaunal abundance and biomass in the North Atlantic Ocean Abyss. *Deep-Sea Research II* 45: 203-224. **(NE Atlantic, Megafauna)**
- Tietjen, J.J., J.W. Deming, G.T. Rowe, S. Macko, R.J. Wilke. 1989. Meiobenthos of the Hatteras Abyssal Plain and Puerto Rico Trench: abundance, biomass and associations with bacteria and particulate fluxes. *Deep-Sea Research* 36(10): 1567-1577. **(Caribbean, Meiofauna)**
- Vasconcellos, M., Watson, R. (2004). Mass balance of Atlantic oceanic systems, p. 171-214. In: Palomares, M.L.D., Pauly, D. (eds.) *West African marine ecosystems: models and fisheries impacts*. Fisheries Centre Research Reports 12(7). Fisheries Centre, UBC, Vancouver.
- Wei, C.-L., G.T. Rowe, E. Escobar-Briones, A. Boetius, T. Salzwedel, M.J. Caley, Y. Soliman, F. Huettmann, F. Qu, Z. Yu, C.R. Pitcher, R.L. Haedrich, M.K. Wicksten, M.A. Rex, J.G. Baguley, J. Sharma, R. Donovano, I.R. MacDanald, C.C. Nunnally, J.W. Deming, P. Montagna, M. Lévesque, J.M. Weslawski, M. Wlodarska-Kowalczyk, B.S. Ingole, B.J. Bett, D.S.M. Billett, A. Yoo, B.A. Bluhm, K. Iken and B.E. Narayanaswamy. 2010. Global patterns and prediction of seafloor biomass using random forest. *PLoS ONE* 5(12): e 15323; doi: 10:1371/journal.pone.0015323.
- Wigley, R.L., A.D. McIntyre. 1964. Some quantitative comparisons of offshore meiobenthos and macrobenthos south of Martha's Vineyard. *Limnology and Oceanography* 9(4): 485-493. **(NW Atlantic, Meiofauna and Macrofauna)**
- Witte, U. 2000. Vertical distribution of metazoan macrofauna within the sediment at four sites with contrasting food supply in the deep Arabian Sea. *Deep Sea Research II* 47:2979-2997. **(Arabian Sea, Macrofauna)**

## LEARNING FROM PEER-REVIEWS: THE GILL-OXYGEN LIMITATION THEORY AND THE GROWTH OF FISHES AND AQUATIC INVERTEBRATES\*

Daniel Pauly

Sea Around Us, Institute for the Oceans and Fisheries, 2202 Main Mall, University of British Columbia,  
Vancouver, Canada  
[d.pauly@oceans.ubc.ca](mailto:d.pauly@oceans.ubc.ca)

### Abstract

Peer review is the cornerstone of modern science, but except for complaints by colleagues about unfair reviews of their submissions, not many personal accounts are available of peer review, and even less on peer reviews actually improving papers. This contribution is based on the comments provided by three anonymous referees to the authors of the paper, later published as Pauly and Cheung (2017; *Global Change Biology*), which defended the Gill-Oxygen Limitation Theory (GOLT) from a critique by Lefevre *et al.* (2017, *Global Change Biology*). The back and forth of arguments between referees and authors, which led to the discovery of a new growth pattern in the common thresher shark (*Alopias vulpinus*) and probably in other elasmobranchs as well, is presented in detailed fashion, and thus represent a case study of peer review performing well. This contribution concludes by making a case for theories (such as the GOLT, whose validity was assessed here) that provide constraints on the expected results of experiments, or sampling surveys. Without such constraints, scientific disciplines such as ichthyology or physiology will not enter the age of ‘big data,’ from which strong inferences can be drawn, but remain tied to ‘small data,’ multiple meaningless small heaps of unstructured numbers and observations.

### Introduction

The way science is done in the 21st century is rapidly moving away from the way it was done in the second half of the 20th century, notably with regards to big data at the ‘meta’ level (Pauly 2017), and to peer-review at the practical, 9 to 5 level.

Indeed, an entire industry, which may be called “Predatory Publishing” has recently emerged which resembles scientific publishing but is not, because it omits peer-reviews. The reasons for its relative success, notably in emerging countries (India, Iran...) are many, but one might be the obscenely large fees charged by ‘open journals’ or to bring single articles across the paywall of other journals. Indeed, one could also speak here of predatory behavior, with ‘only’ peer review marking the difference between the two business models.

Peer review, which may thus be seen as a service provided freely by scientists to scientific publishers to help them distinguish themselves from “predatory publishers” is, however, also a great help to scientists, as it usually helps improve their papers.

As individual scientists tend to only complain about incompetent and/or malevolent reviews, and editors tend to be mum about reviews, there are relatively few good examples of the review process that make clear, in practical terms, why peer review is good for science, or at least for many individual papers.

What peer review can add to a manuscript is illustrated here, in some details, by a case study whose antecedents are as follows:

- 1) In 1981, the author published, based on his dissertation, the basic elements of what will be called below the Gill-Oxygen Limitation Theory (GOLT), i.e., why the gills of fishes and other water-breathers (e.g., crustaceans and mollusks) cannot grow as fast as the bodies they must supply with oxygen (the scaling factor in question,  $d_G$ , is assumed to always be  $< 1$ ), and hence must limit their growth rate, maximum size, food conversion, etc. Subsequent contributions (notably Pauly 1984, 1998a, 1998b, 2010) added empirical evidence to the GOLT;

---

\* Cite as Pauly, D (2018) “Learning from Peer-reviews: The Gill-Oxygen Limitation Theory and the Growth of Fishes and Aquatic Invertebrates,” Pp. 53-70. In Pauly D. and V. Ruiz-Leotaud (eds.) Marine and Freshwater Miscellanea. Fisheries Centre Research Reports 26(2). Institute for the Oceans and Fisheries, University of British Columbia.

- 2) Based on the GOLT, Cheung *et al.* (2013) estimated, using a single generic values of  $d_G = 0.7$ , a decline of the maximum size that fish can be expected to reach in the future, given ocean warming;
- 3) Three physiologists, Lefevre *et al.* (2017), published a critique of the paper in (2), asserting that the Cheung *et al.* (2013) paper was fundamentally flawed, because gill respiratory area grows in response to the oxygen demand of fish, and that this growth can keep up with the 3-dimensional growth of a fish body. Moreover, they also accused Cheung *et al.* (2013) - without evidence - to have deliberately chosen the value of  $d_G = 0.7$ , in the model they developed to predict the effects of temperature, such that it would generate a large decrease of size from a modest ocean warming.
- 4) Pauly and Cheung (2017) rebutted these claims, notably demonstrating that using more detailed values of  $d_G$ , ranging from 0.7 to 0.9 generated stronger size decreases than reported in the 2013 paper.

This contribution consists, in the main, of the reviewers' comments (all numbered, in italic and starting with @) and the responses to the peer review of Pauly and Cheung (2017), in form of a letter to the editor of *Global Change Biology*, drafted by this author, and which dealt with the constructive comments of three anonymous reviewers of the submission, now published as Pauly and Cheung (2017). This contribution, thus, is best read along with the paper by Pauly and Cheung (2017) at hand, lest things may get confusing. Also, the start of the letter is very tedious. However, as the arguments go back and forth, the stakes become higher, and the reviewers' questions more incisive. This is where the benefits of peer review manifest themselves.

The text below was minimally edited for typographical errors and flow; notably, all references to line numbers were replaced by in-text locations. The text in square brackets was inserted later for better comprehension and/or to provide additional information. The figures with Arabic numerals (1, 2, 3...) are those included in the draft whose reviews are discussed here, or related papers; the figures with Roman numerals (I, II, III) are those included here to illustrate key concepts. Also note that 'fish', in the following, refers to finfishes (Pisces) as well as invertebrates breathing water through gills.

## **A letter responding to reviewers' comments**

Dear Editor, Please find attached the manuscript "*Sound physiological knowledge and principles in modelling shrinking of fishes under climate change*" which we revised based on the comments from three thoughtful reviewers. In the following, their comments are addressed individually; our responses indicate how the comments were accommodated in the revised text. We believe that the revised manuscript addresses all the comments raised by the reviewers and you. Thank you for your attention. Best wishes.

### Editors' comment

@1) This is clearly a very important topic and one that has consequences beyond biological knowledge. We therefore want to ensure that the submission is the best it can be as we have no doubt it will bring forth a lot of discussion. In the main, we do feel the authors have tackled the key issues but there are still some outstanding points and some of the claims need to be more firmly supported by evidence and examples. These points are very clearly articulated by, in the main, supportive reviews. We ask the authors to address all these issues or if they disagree with any, that they clearly state their reasoning. We also agree with reviewers that this MS does offer an excellent opportunity to really further understanding and knowledge and ask the authors to consider this point when choosing the language they use to layout their key arguments. We do feel that a constructive approach would be best. We look forward to seeing the revised version.

We fully agree with this assessment and we document, in the text below, how we implemented the reviewers' suggestions.

### Reviewer #1

@2) I agree with the authors that a response was needed to Lefevre et al. (2017) who challenged both the physiological basis and the resulting predictions of theory that predicts body size changes with warming, especially in fish. These size changes are scientifically and socioeconomically important aspects of global change biology. The response by Pauly and Cheung provides lots of useful support for the oxygen-limitation hypothesis, its underlying mechanisms, and its consistency with a variety of other observations. It rebuts many of the assertions of Lefevre et al. and provides novel predictions based on matching the allometric scaling exponent of gill surface area more closely to that of the fish.

We are delighted about this overall assessment.

@3) However, the responses to two important arguments of Lefevre et al. – relating to the scaling of surface area of folded gills, and the mass invariance of 'maintenance' metabolic rate – were not entirely convincing, and would benefit from more fleshing out.

We agree, and have amplified and differentiated our responses; see below.

@4) Also, the response sometimes over-concludes beyond the evidence presented, and sometimes distracts with text that is inappropriate to a logical, evidence-based scientific discourse.

These issues are discussed below. We have adjusted our text as suggested; see below.

@5) The first issue of Lefevre et al. is that because of the 'folded' nature of fish gills, it is possible, in principle, for their surfaces to increase directly with body mass by just adding to the radius of lamellae, to the length or number of filaments (hence numbers of lamellae), or both. In response, the authors (after a discussion about

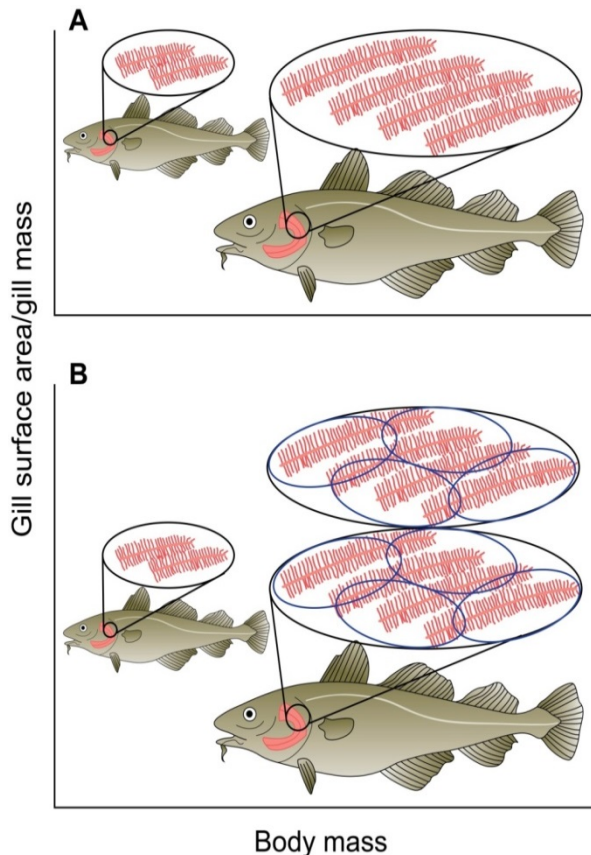

**Figure 1.** Unmasking a grave error in a schematic graph meant to explain that fish can always grow gills as required for maintaining the same gill area per unit weight. Panel A, copied from Lefevre et al. (2017) is supposed to illustrate that a fish, when growing, simply acquire more gills, as illustrated by the fish on the right. Note that this fish, which is 2 times longer, is  $2^2 \times 2^2 = 8$  times heavier than the fish on the left. Panel B shows the approximate gill area (symbolized by the red feather-like drawings) that would be needed by the heavier fish to maintain the same gill area/body weight as the small fish. Panel B would have been honest; however, the readers of Lefevre et al. (2017) would have seen that it did not make sense.

surface area constraints that could be largely culled as it skirts around this specific issue) eventually argue that the gills just don't have enough room in the gill cavities to achieve this. But this argument implies that the gill cavity volume does not scale isometrically with body volume. And so this begs the question why doesn't the gill cavity volume scale in direct proportion with body volume (or mass)? This issue needs to be taken to a more convincing and satisfying conclusion.

We agree that we skirted around the claim of Lefevre *et al.* that gill lamellae can be compared to pages in a book, i.e., disembodied two-dimensional entities that can be stacked at will and will keep up with a growing volume (we initially thought that the flaws of this argument would be immediately obvious to any reader). We now respond to this argument in the revised text, where we point out that if the analogy with pages can keep up with a volume holds only if a book is not read, i.e., if no space between the pages is required. Similarly, gill lamellae are 3-D objects that not only must accommodate capillaries of sufficient diameters for red blood cell to pass through, but also require space because water must be able to flow along their surfaces. We thought this was self-explanatory, but realize now it must be explicit, given the subtlety of the error in the pages-in-a-book analogy. Thus, text to this effect was added. [See also Figure I].

@6) *The second important issue of Lefevre et al. is that mass-specific metabolic rate for 'maintenance' may not be constant with increasing body mass. They refer to studies in which the standard metabolic rate has a scaling exponent less than 1 (importantly this should be during ontogeny, not interspecifically). An important consequence of this for predictions of body size shrinkage with warming is that if this scaling exponent is less than 1, it will lessen the reductions in body size with warming predicted by the von Bertalanffy growth model used by Cheung et al. (2013).*

Agreed. In the original submission, we alluded to this issue in passing, when referring to the insert in Figure 2 [of Pauly and Cheung 2017], which illustrates, via two examples (dotted lines), two possible trajectories (i.e., scaling factors) for the relationship between maintenance metabolism and body weight. We have now amplified our comments on this issue. However, we also point out the difference between the trajectories is large only to young/small individual, while size reduction would show up in old/big individuals. Also, there are two other factors that work against this bias (see below). In addition, we added to the revised manuscript that having a scaling exponent less than 1, given the constraint that fish stop growing at asymptotic size (when anabolism = catabolism), does not affect the use of the Gill-Oxygen Limitation Theory to infer that fish maximum body size decreases with warming. We also noted that if the difference between the trajectories is large, then the shrinkage that Cheung *et al.* (2013) will be overestimated.

@7) *Because the value of this exponent affects their model predictions, it should be discussed earlier in the paper. The authors acknowledge that a change in the scaling of standard metabolic rate is reasonable, but do not then make it sufficiently clear why maintenance metabolism should still be considered directly proportional to body mass. In other words, the authors need to justify why standard metabolic rate is not a measure of maintenance metabolism, and provide evidence of how these two scale differently with body mass. The authors do say that a 'minimum metabolic level, which will occur at smaller sizes when higher temperatures cause protein to be denatured faster, is what limits the size of fish (Figure 2).' Thus, the authors appear to be implying that standard metabolic rate is not maintenance metabolic rate.*

We thank this reviewer for pointing out that we did not define all our terms, notably standard metabolic rate and maintenance metabolic rate, the difference of which is crucial to our argument. We now explain this earlier in the main text in the revised manuscript. We also added a short glossary to explain key terms [see Table 1 in Pauly and Cheung 2017].

@8) *[The authors] also should give a fuller description of what may be problematic at high temperatures besides just protein denaturation (e.g. membrane permeability, ion pumping csts).*

Agreed. We now mention some of the added costs of high temperature. However, we maintained our emphasis on protein denaturation, because its major consequence is that the denatured proteins must be re-synthesized, which require ATP, which itself requires oxygen that comes from the gills.

@9) *Table 1 gives illustrative values of mass-scaling exponents for gill surface area and metabolism. Isn't a more thorough analysis possible with available data?*

We agree that a more thorough analysis of data such as those in [now] Table 2 [of Pauly and Cheung 2017] could be performed. The point of this table, however, was to document both the central tendency (for most teleost fish past metamorphosis) and extremes values (tuna, gobies, fish larvae) to define the terrain within which the discussion occurs, and provide key references in context.

*@10) How can the reader be convinced that these examples are illustrative of general trends among the teleosts, rather than selected to support the authors' thesis?*

If our readers assume bad faith or chicanery on our part, then even a table 10 times larger could not convince them that we are not cherry-picking. Moreover, the syntheses cited in this table are classics which were, at the time that were published, the most comprehensive studies available on the topics in question.

*@11) Which metabolic rate is used? It should be maximum metabolic [rate], to be related to oxygen supply limits. If it isn't MMR, the data should not be included in the table.*

Here, we must respectfully disagree. Maximum metabolic rate can be, in nature, sustained only at a high cost to general fitness (a point made by Priede 1985, and which we illustrated with Figure 1 [in Pauly and Cheung 2017]), and cannot be used for such comparisons. Our explanation is now elaborated in the text.

*@12) Figure 2 needs better labelling or explanation. Is the curve fitted by eye to gill area/body weight (y-axis label), and then assumed to be directly proportional to maximum metabolic rate?*

We agree to the need for a better caption. There are two bivariate graphs in Figure 2 [of Pauly and Cheung 2017]. The main one shows straight regression lines fitted by least squares to gill area/body weight data pairs. It shows, for carp, that gill surface area can grow faster than body weight in in very small and small individuals (as in Table 2). Then, the expected post-metamorphosis scaling ( $d_G < 1$ ) establishes itself at about 1 g. The smaller bivariate graph (insert) presents the same data, but as gill area per body weight. Therein, the two dotted lines are hypothetical examples of possible alternative trajectories for the maintenance metabolism. We have modified the caption to make this clear, and now mention 'hyperallometric' growth, as requested.

*@13) The scope for growth is derived from comparing this curve with a horizontal line, but see Point above, about whether a horizontal line is justified. Also, the line is not measured in units of gill area/body weight, so the axis labelling is incomplete.*

Agreed; we have expanded and clarified the caption of Figure 2 [in Pauly and Cheung].

*@14) The application of a size-specific value for the scaling exponent  $d_G$  for uptake, produces a very interesting result – that body size shrinkage with warming is expected most in larger species. If this is borne out with data, it would extend to larger species the finding of Forster et al. (2012) that warming reduces adult size of larger aquatic ectotherm species more than that of smaller species.*

We agree with this assessment. Forster et al. (2012) is now cited. Note that this effect would also strongly counteract the overestimation of shrinkage that we conceded earlier.

*@ 15) Text [in the Introduction, referring various examples of surface/volume tensions] inappropriate to a concise, logical, evidence-based paper. All of it!*

We respectfully disagree. As mentioned by Reviewer #2, in this paper, we must be didactic, to draw readers in. Nothing is better for this than powerful imagery. Moreover, an important point is being made: near-perfect adaptations even to difficult conditions have the effect of masking the underlying challenge. This is later elaborated upon with regards to the extraction of oxygen from water, which, we argue, is a challenge for water-breathing animal such as fish.

*@16) While [the content of the section titled "Biological surfaces as a ubiquitous constraint"] is correct, it is not directly addressing the particular issue raised by Lefevre et al., which is concerned with how the specific folded geometry of gills enables the usual surface area constraints to be potentially overcome (see above).*

The section on 'Biological surfaces as a ubiquitous constraint' presents the fundamental elements of what will be called 'Gill-Oxygen Limitation Theory' (GOLT), which is a special case of 'dimensional tension' (see new glossary). Without this section, our argument would be nothing but special pleading, i.e., for fish being 'different'



from other organisms just because we study them. [The glossary defines ‘dimensional tension’ as “our term for the interactions of biological (and other) processes wherein the growth of a process in a certain dimension (typically a surface) limits the growth of a related process unfolding at a higher dimension (typically a volume). Dimensional tensions strongly impact the architecture of growing organisms because they cannot easily be circumvented by evolutionary adaptation”].

@17 [Text to be removed] *‘and elsewhere, as we will see when we begin to study extraterrestrial life.’*

We have modified this to read “...as we might see...” The point here is that the GOLT is built from first (geometric) principles, and is meant to be ‘substrate-independent’, just as gravity is. There is no reason why we should accept that physical or chemical ‘laws’ should work on other worlds, but not biological one (e.g., Natural Selection). This is important here because near the end, Lefevre *et al.* appear to argue that different principles apply even to different rivers. Here we claim the exact opposite.

@18) [Statement] *‘This is due to something called scientific progress’ This sounds like something called condescension. Just remove the ‘something called’.*

Agreed. This is now edited as suggested.

@19) *Over-concluding beyond the evidence presented [several examples] ‘This is the reason...’ (or similar). More appropriate would something like ‘this is consistent with...’*

Agreed; changed as suggested.

@20) *What is the specific nature of the constraints [to gills growing as fast as a volume]? [Asserting that] Lefevre et al.’s argument about folds and number of lamellae does not hold [is not enough]. No evidence is presented for why fish ‘cannot’ grow gills whose surface remains proportional... Also, you say ‘Indeed, if they could, they would’ Who can know this?! The authors need to write for a critical scientific readership, not one who shares the authors’ beliefs.*

We see now that we should have dealt with the gill-lamellae-as-pages-in-books analogy of Lefevre *et al.* in our original submission, because refuting this misleading analogy also explains why fish cannot grow gill whose surface remains proportional to their weight. This is now done [See also Figure I in this contribution].

@21 *For ‘comes along with understanding that’ I suggest ‘emerges from the theory that...’*

Agreed; changed as suggested.

@22 *While the argument of Lefevre [regarding catabolism] is correctly identified as being incorrect, the quotation of von Bertalanffy is not quantitatively logical: because all living cells catabolise doesn’t mean that catabolism is directly proportional to body mass. In principle, the proportion of different tissues or structures with different metabolic intensities may scale allometrically during ontogeny, so that overall, metabolic rate is not directly proportional to body mass (as has been observed recently in insects by Maino and Kearney).*

We agree that one can easily conceive of post-metamorphosis fish whose gross morphology (and proportions of cell and protein types) would change (say due to acquisition of an armor, from rapidly denaturing muscle cell proteins to more slowly denaturing bone cell proteins), which would change the overall denaturation rate. Indeed, in the book by Pauly (2010), cited in the paper, two such cases are discussed: the seasonal deposition of visceral fat, marked in fish exposed to strong summer-winter temperature differences, and the gradual ‘jellification’ in some species of flatfish (Pleuronectiformes), where big/old specimens can reduce their metabolic requirements by converting part of their bodies to acellular ‘jelly.’ However, dealing with these exceptions (which do not lead to contradictions anyway) in the context of our paper would make it exceedingly long. We believe, moreover, that in the spirit of parsimony, there is no need to assume in the absence of supporting evidence that radical changes in tissue composition routinely occur in fishes. [This contradicts the findings of Maino and Kearney (2014, 2015) of massive changes in tissue composition and metabolic rate in the ontogeny of insects, but then, young fish do not differ from older fish the way insect larvae differ from the adult forms; we forgot to make this point and thus to cite “Maino and Kearney”].

@23) Wording/meaning unclear [in the caption of Figure 4: 'Average' - Is this the mean or median? The value for the latter on Fig.4 seems to be greater than 30%. Does the figure show the median and the text describe the mean?]

The median values are now reported in the revised manuscript, which is consistent with the figure.

@24) Typographical errors [list followed].

Thanks for pointing out these errors; they are now all fixed.

## Reviewer #2

@25) This manuscript is a response to a rebuttal (Lefevre et al. 2017 *Global Change Biology*) that argued against the idea and model results from Cheung et al. (2011, *ICES J. mar. Sci.*; 2013, *Nature Climate Change*) that fish body sizes will become smaller in the future under ocean warming conditions. These original papers (Cheung et al. 2011; 2013) based their models and underlying assumptions that Lefevre et al. (2017) challenged. In turn, this current manuscript responds to the challenges Lefevre et al. (2017) lays out. This series of papers highlights the current tension between physiologists and ecologists, in which physiologists generally believe that metabolic rate constrains gill area and ecologists generally believe that gill area constraints metabolic rate.

The last sentence of this paragraph is very well put, though we do not believe that there are many aquatic ecologists who think about gills, unfortunately.

@26) The assumptions that Lefevre et al. (2017) question and this manuscript attempts to provide evidence for are in regard to how gill surface area increases with increasing body mass (i.e. the scaling exponent of the relationship of gill surface area and body mass,  $d_G$ ). Specifically, these assumptions made originally by Cheung et al. (2011 and 2013) and upheld in this manuscript suggest that geometric constraints on gills result in the gill surface area not growing as quickly as body mass (i.e. gills can only grow as fast as surface area to volume ratios allow, resulting in a scaling exponent of 2/3) and thus, limit the growth and metabolic rate of an individual.

We agree almost completely with the content of the above paragraph, except that gills, while functioning as 'surfaces' for the exchange of gases (see below) do not need to grow with a scaling exponent of 2/3. In fact, we show (e.g., in Table 2) that this exponent can range in fish between 0.55 and 0.95. The point we make is that, in post-metamorphosis water-breathing fish, the scaling exponents cannot be equal to unity for long, and pertain to functioning gills (see below).

@27) Pauly and Cheung draw heavily on the original Pauly papers from the 1980s and a recent synthesis published as a book in 2010. Furthermore, Cheung et al. (2011, 2013) and this manuscript argue that this constraint on growth and metabolic rate imposed by gill allometry results in a decrease in fish size. This is because the amount of available oxygen will decrease for a given depth and location as ocean temperatures increases, and the gill area will not be able to keep up with the oxygen demand of the fish species, as indexed by the maximum, asymptotic weight [ $W_\infty$ ]. The core feature of the Lefevre et al. (2017) argument is that gills, specifically the surface area, are not under geometric constraints and thus can grow proportionally to body mass [ $M$ ]. Specifically, they argue that gill filaments, like book pages, can be added in a manner that is proportional to overall surface area, i.e. the scaling of Gill Area  $\sim M^{d_G}$ , where  $d_G$  can be = 1.

We agree with every word in this paragraph. In our original submission, we avoided dealing with gill-lamellae-as-pages-in-a-book comparison, mainly because it seemed like a digression, but now realize that we must bite the bullet, and explain why this analogy doesn't work, or rather, why it lacks a key element. The *raison d'être* of books is to be read, and hence they have to allow for 3-D space above their pages. Similarly, the *raison d'être* of gill lamellae is to pick up O<sub>2</sub> from the surrounding water, and to release CO<sub>2</sub> into it. Moreover, this water must be passing by the lamellae, i.e., old water must replace by new water. None of this can occur in 3-D. We have attempted to express in a new paragraph on why 3-D gill lamellae would not work. [A graph explaining this via an analogy to a car's radiator is provided here as Figure II].

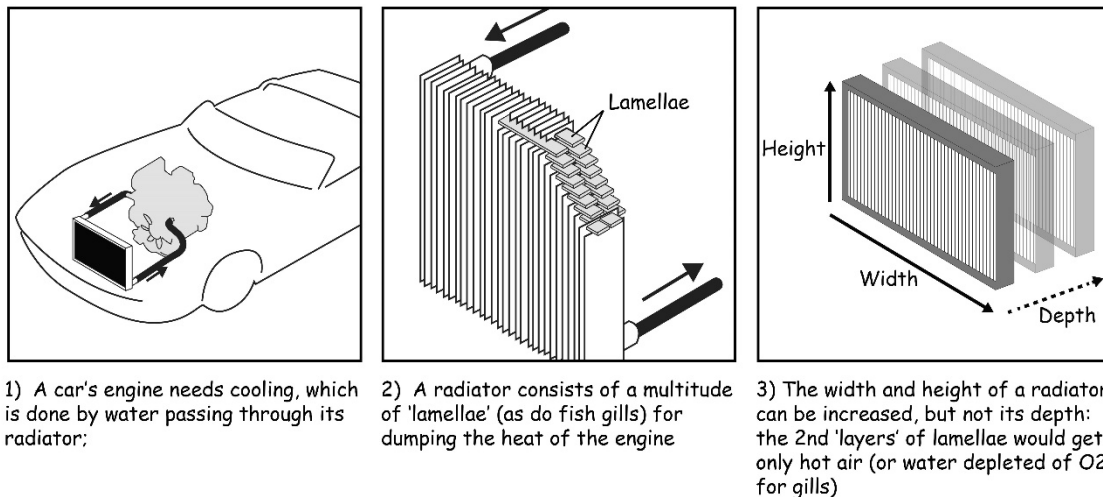

Figure II. Illustrating, in form of a 'comic strip,' that cars' radiators fulfil their function by exposing their lamellae to an airflow that warms the water circulating through the radiator. After air has flown across lamellae, it is hot. Thus, putting a radiator behind a radiator does not make sense, and radiators can grow in width and height (2-D), but not in width and height and depth (3-D). This is similar to gills, whose lamellae extract oxygen from the water passing through them.

@28) Furthermore, as Cheung *et al.* (2013) document in the supplementary material, Lefevre *et al.* (2017) state that the scaling exponent resulting from the relationship of gill surface area and body mass, and used in Cheung *et al.* (2011, 2013) will have a great influence on model results that attempt to estimate the decrease in fish growth in response to ocean warming.

Yes, and the shrinking effect is much stronger when variable and higher scaling exponents are considered (See Figure 4 in Pauly and Cheung 2017) [These findings are based on simulations designed by William Cheung, and whose mathematical background is documented in [https://docs.google.com/viewerng/viewer?url=http://www.nereusprogram.org/wp-content/uploads/2017/08/Short-notes-on-body-size-calculation.pdf&hl=en\\_US](https://docs.google.com/viewerng/viewer?url=http://www.nereusprogram.org/wp-content/uploads/2017/08/Short-notes-on-body-size-calculation.pdf&hl=en_US). These facts contradict Lefevre *et al.*'s allegation that we chose a low scaling factor so as to boost our case. (Accusing people of such shenanigans without a shred of evidence is not very professional, incidentally).

@29) While Pauly and Cheung thoughtfully argue that Lefevre *et al.* (2017) are incorrect in refuting the original assumptions made by Cheung *et al.* (2011, 2013), this manuscript is not likely to be influential in successfully arguing against the core of Lefevre *et al.* (2017) rebuttal. This is largely for two reasons that, if tackled, would greatly improve the manuscript. The first improvement is to reframe this paper in terms of constructive rather than destructive criticism. The authors can win the battle by dismissing Lefevre *et al.*, but they have a wonderful opportunity to didactically lay out their theory to a larger audience. After all, disagreeing with other scientists' ideas, analyses, results, etc. and thoughtful discussion of these disagreements is what moves the field forward.

We agree that the Lefevre *et al.* paper offers a good opportunity to elaborate on the ideas in Cheung *et al.* (2013), and the underlying theory in Pauly (2010), and this is the reason, indeed, why we responded in the first place, even though we viewed the arguments of Lefevre *et al.* (2017) as so deeply flawed that we first thought a response was superfluous. However, their paper is a direct attack on the fundamentals of a theory which could allow us to understand the effect of warming on water-breathing animals, and this attack cannot be dealt with without their authors being contradicted and their argument refuted one by one. If we do not refute their points, the readers will think that we have no arguments. The important thing, however, is to use proper language, and thus we accepted all the reviewers' suggestions for avoiding provocative language.

@30) Secondly, this manuscript greatly suffers from the logical fallacy "false cause," or using a simple correlative relationship between two variables to prove causation. In this manuscript, the authors' state that "Indeed, the very fact that in most fish, gills grow with a positive allometry is an indication that the O<sub>2</sub>-supply that these fish experience is a limiting factor for them, and does not meet their demand." An allometric

*relationship between gill surface area and body mass (to be clear, an exponent  $> 2/3$ ) does not prove causation. The causation question of which constrains which (i.e., gill surface area constraining metabolic rate or metabolic rate constraining gill area) has not been directly tested, and examining the mass-scaling of each does not test the causation, only the correlation. While the mathematical elements and implications of the scaling of gill area and body mass are elegant, the authors should take the time to be more didactic in order to reveal their reasoning behind the proposed causality to the reader, especially to readers who might be more used to experimental approaches.*

Here, we must respectfully disagree, because we are well aware that “correlation doesn’t prove causation”. Indeed, we would put it more precisely: correlation, while a *necessary* condition for causation, is not a *sufficient* condition. For sufficient conditions, we must look for corroborations, i.e., alternative lines of evidence. And we must also realize that, strictly speaking, we never will get the evidence to convince a determined skeptic, because he or she could argue that each alternative line of evidence is also questionable, and so on *ad infinitum*. We have to stop (if temporarily) at some point, i.e., when there is clearly more evidence on one side than on the other. This is why we listed, near the end, a list of scientific problems that are resolved if we assume the causation arrow to go our way, and which cannot be explained if the arrow goes the other way. Indeed, we think that this was the best way “*to didactically lay out [our] theory to a larger audience.*”

@31) *Furthermore, in addition, much of this manuscript suffers from unclear writing.*

We agree that our writing can be improved and hope to have done so, thanks to the reviewers. We note, however, that Reviewer #3 suggested that “[t]he manuscript is clearly written and easy to read.”

@32) *[This manuscript suffers], as well [from] poor examples that do not corroborate the authors’ intended point.*

Here, we are at a loss: what other kind of examples are being suggested?

@33) *The authors seem to be so convinced of the point they are trying to make (that geometric constraints on gill area limits growth) that the oversimplification of explanations hinders the audiences’ ability to understand just what is so convincing. This includes the supporting examples; although the authors try to substantiate their ideas with examples, these examples need to be expanded upon or changed to ensure that the writing is clear and that examples are corroborating intended points (see major concerns below).*

We cannot follow up on this point, as no example is given of how our examples fail to convey what they are intended to.

@34) *Major Concerns: Reframe from destructive language to constructive language: This includes seemingly trivial instances (e.g. the word “huge”).*

Agreed. The word ‘huge’ has been twice replaced by ‘wide.’ We have also revised the text to turn destructive language into constructive language.

@35) *The authors claim that there are no other major hypotheses to explain a huge range of biological features of fishes. For example, the metabolic theory of ecology offers a plausible alternative without even needing to consider respiration. As Pauly himself claimed back at the FSBI meeting two decades ago that these constraints should equally apply to mammals.*

There must be some misunderstanding: [the author] would never have claimed that respiration is a limiting factor to the growth of mammals and other air breathers. Claiming this would instantly invalidate the reason given for the claim actually made, i.e., that gill growth and hence oxygen supply limits the growth of water breathers. As for the explanatory power of (i) the metabolic theory of ecology and (ii) the theory of West *et al.* (1997, 2001, 2003) of branching distribution networks, I have not seen any attempts by their practitioners to actually explain simple phenomena, such as why fish grow larger when they are in colder water, of why size at first maturity is a simple function of the maximum size reached in a given population, etc. (I am certain that they can represent these phenomena, but how many new parameters do they need to introduce for this?). Lack of space prevents us from dealing with alternative theories. However, we have now mentioned in the revised text that Pauly (2010) discusses both the metabolic theory of ecology and the theory of West *et al.* (1997, 2001, 2003) of branching distribution networks.

@36) One major point that refutes Lefevre et al. (2017)'s main argument that gills are not limited by geometric constraints and can in fact scale with body size to an exponent of  $> 1$  is not mentioned in this manuscript. This point is that in some fishes, particularly highly active obligate ram ventilators, gill area is not increased by reducing space between individual lamellae (Lefevre's book pages) and instead, is achieved by lengthening the gill filaments (see Wegner et al. 2010 *Journal of Morphology*).

This is a good point and we have now mentioned lengthening of gill filaments and cited Wegner et al. (2010). We were aware of papers on ram ventilation, but opted to 'not go there,' because even in specialized ram-ventilator such as tuna, the gills scale with body mass with 0.9 and not unity, which is sufficient for our point to be valid.

@37) Revise writing to ensure that it is clear and explanations are fully explained with supporting examples; specific instances to this comment below as line-by-line comments: Despite the term "physical constraints" being used several times throughout the manuscript, it was not defined and the meaning remains unclear.

Now clarified via the added glossary. [The glossary defines physical constraints as "the non-biological processes or features that have shaped the evolution of organisms and still shape their performance. Examples are gravity or the dissolubility of oxygen in water].

@38) What is meant by "open surfaces"?

See new glossary. [The glossary defines open surfaces as "the surface of a body organ (e.g. the skin, or the gills) that is in direct contact with an outside medium. Open surfaces can be used for the transfer of heat, or gas (O<sub>2</sub>, CO<sub>2</sub>), or liquid (sweat). In this, open surfaces differ from the outer surfaces of internal organs (e.g., the liver), which only separate them from other organs."]

@39) Authors are not consistent throughout document in regards to what they are calling their theory; here, it is "gill area limitation; it is "Gill-Oxygen Limitation Theory.

Agreed. We now call it Gill-Oxygen Limitation Theory (GOLT) throughout.

@40) [In the introduction], what are the "different mechanisms" relating warming and decrease in body size? The authors should explain to support their claim that "biological constraints on size-related physiological and ecological processes."

We agree that the sentence in question was messy. We have rephrased it, to better introduce the constraints in question.

@41) [Paragraph in the introduction dealing with animals in nature misleadingly suggesting they are free of constraints]. This is not relevant to the paper and does not support the authors' argument.

We respectfully disagree and kept this paragraph unchanged (see also above, item 15).

@42) What is the "maximum capacity imposed by physical constraints"? Is "maximum capacity" the same as the term used 4 lines later, i.e., "maximum physiological capacity"? These sentences are uncited and need citations; one could use the argument against symmorphosis here to corroborate point.

Yes, it refers to maximum physiological capacity. We have clarified this in the revised manuscript. [And we have not dealt with symmorphosis].

@43) The plaice example does not support the point that it is costly to fitness to approach the maximum physiological capacity.

We think that the plaice is a relevant example to explain and support our point. The authors of the paper from which it was drawn [Fonds et al. 1992] explicitly state that "for a given supply, the energy spent in active (swimming) metabolism is the main variable component in the energy budget: a very active fish will grow less." We know that "less growth" results in more predation and smaller egg production, both fitness-reducing factors. This is what is behind Figure 1 [in Pauly and Cheung 2017]. Therefore, if plaice is more active in feeding, it is energetically costly and its growth is limited. This is now clarified in the revised manuscript.

@44) *[The text dealing with physiological limits in the wild] needs a citation here so reader can go back to original citation to further understand point that the authors' are attempting to make.*

Agreed; we added a citation.

@45) *What do the authors mean by "strongly limiting"?*

A definition of 'limiting factor', going back to Justus von Liebig was added to the glossary. [This definition is: "a variable which, when increased, causes the performance of a system to increase. The concept is understood since Julius von Liebig (1803-1973) demonstrated that increasing agricultural productivity, at any time, was a matter of providing more of the single element that constrained productivity (e.g., phosphorus), and not more of all the nutrients that are required overall." We forgot to define 'strongly limiting', but it should be obvious.]

@46) *The authors explain isometric and allometric here in an interesting manner, that requires some context for those that work on other forms of allometry. To improve the consistency of the use of these terms in the metabolic and gill mass-scaling literature, I suggest that (hyper-)allometric be defined as a mass-scaling exponent  $> 2/3$  and an isometric mass scaling exponent  $= 2/3$ . The authors fail to make the connection between the length and mass/volume ratio for the reader that the isometric scaling exponent expectation is calculated by dividing  $L^2/L^3$ . The authors should be cognizant that isometry typically means scaling to a power exponent of 1, say for brain mass relative to body mass, but in this field of gill and metabolic scaling, isometry is  $2/3$ . Please use this term correctly and didactically to enable a broader range of readers to grasp the working hypothesis.*

We agree to use 'isometric' for a scaling exponent of  $2/3$ , because it implies that volume grows with the 3rd power of length and surface growing with the 2nd power of length, i.e., with the power the 'same' (= 'iso') as the dimension itself. Hyperallometry will then mean  $>2/3$ , and hypoallometry  $<2/3$ , i.e., 'different up' and 'different down.' We have added these terms to the glossary.

@47) *The spider example [in the section on 'Biological surfaces as a ubiquitous constraint'] is not clear and does not seem to support the authors' intended point. To keep the reader focused on the main point, please drop the cross-sectional area arguments, the insect trachea and whale flukes. These are great points dealt with in the book, but a sidebar to the issues at hand. Keep the reader focused on the pertinent core points.*

We respectfully disagree. Above, the same reviewer required that we lay our case in didactic fashion, such that it can be understood by a wide range of readers. Analogies help understanding. The specific example is to help explain the concept of allometric growth, which in comparative evolutionary studies, is particularity noticeable in response to a physical constraint, here gravity.

@48) *What [is] allometric growth?*

This term was originally defined as the growth of an organ or body part at a rate exceeding or different (= 'allo') from that of the rest of the body. We define this in the new glossary. [The glossary now defines Allometry as "a term coined by Julian Huxley (1887-1975) to characterize the growth an organism's part when it proceeds at a rate different ('allo' = other) from that of the organism's body as a whole."].

@49) *Do not use the word "obvious" when something is not.*

Agreed. We rephrased the sentence in question, and omitted the word 'obvious.'

@50) *It is unclear as to how the whale example of dumping heat relates to the issue of dimensional tension.*

Heat is produced by and in a muscle volume (within 3-D), and can be dumped only via a surface (across 2-D). This is a clear-cut case of dimensional tension, and one which had great practical implications, as many of the whales hunted in previous centuries could be caught only because they overheated after being chased for a while. This is also the reason why the San people in the Kalahari can run down antelopes which don't sweat and must stop running when they become too hot (Liebenberg 2013). Again: we are using example of dimensional tension that a reader can understand, so she or he can appreciate the concept when applied to gills and oxygen supplies to fish.



@51) The fact that gills grow allometrically relative to body mass does not answer the question if gills are limiting growth in terms of O<sub>2</sub> supply. Obtaining a scaling exponent from a relationship of gill area and body mass does not mean causation and is not the correct test to answer the causality question. Again, please consider the scientific method for establishing causality and respect that factorial experimental evidence is the only way to do this.

Evidence gained from factorial experiments is not the only evidence suitable to establish causality in science. If this were the case, most of geology, astronomy and cosmology and - for that matter evolutionary biology - would not be scientific. Rather, in science, we test hypotheses which must have two major properties to be interesting: (1) they must be testable in principle (which is the reason why, e.g., string theory is being increasingly challenged by various physicists) and (2) they must predict observations different from those used to derive them in the first place. Also, a given hypothesis will be much preferred over an alternative hypothesis if it is (3) more parsimonious; (4) explains observations in widely different subfields or fields; and (5) is consistent (or 'consilient') with related, well-corroborated theories [Wilson 1999]. This is why we give examples of the wide applicability of the GOLT. These are now explained at the beginning of the manuscript.

@52) While the gill ablation experiment is compelling it would clearly be very difficult to 'add' surface area to gills to provide a stronger experimental test. Humor the audience of experimental physiologists by at least framing the narrative in terms of strength of evidence.

Agreed. In fact, it is precisely because it is difficult to experimentally 'add' gill area that we use comparison between related species differing in their gill areas. On the other hand, we did not mention that gill ablation experiments support our case; we now mention this and cite an example.

@53) See the following citations for an example of scaling exponents of gill area to body mass  $>1$  indicating that gills can grow in proportion, or even faster, than body mass in some fishes: (1) Table 3 in Satora and Wegner 2012 Reviews in Fish Biology and Fisheries (2). Table 4.3 [sic] in Wegner 2015, Ch. 4 [sic] in Fish Physiology of Elasmobranch Fishes: Structure and Interaction with Environment, vol. 34A; and (3). Figure 1 in Wootton et al. 2015 Journal of Morphology.

In response to this comment, we added a case study of the common thresher shark, based on Wootton *et al.* (2015) and Table 3.3 of Wegner (2015), in Chapter 3 of the book in question. While these authors emphasized a scaling exponent of 1.03, pertaining to smaller individuals, they excluded data pertaining to threshers of greater body sizes, which yielded a much lower scaling exponent (0.41), and which they arbitrarily pronounced erroneous (See Table 4.3 in Wegner 2015). However, we show [in the new Figure 3 of Pauly and Cheung (2017); see also Figure III] that this value of 0.41 is in fact neither erroneous nor anomalous, and can be explained by the GOLT [as a necessary transition of an unsustainably high value of  $d_G$  to a low value, as should occur if gills surface area is limiting the maximum size of the shark].

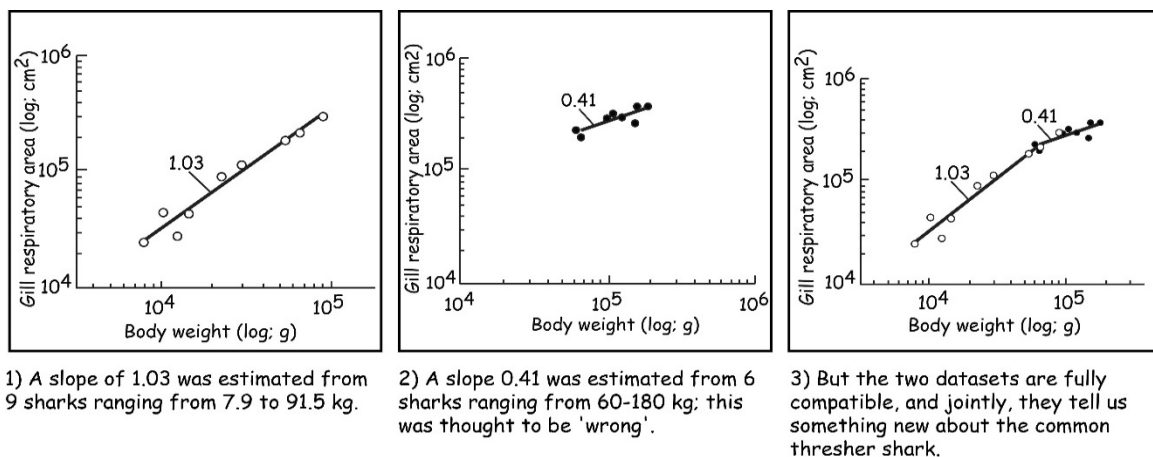

Figure III. Illustrating, in form of a 'comic strip' how two datasets, from Wootton *et al.* (2015) and Emery and Szczepanski (1986), respectively, on changes in gill surface areas in common thresher shark (*Alopias vulpinus*), previously thought to be incompatible (which implies that one should be 'wrong'), are in fact perfectly compatible and led to a discovery about the growth of *A. vulpinus* and possibly other elasmobranchs (see text).

[We forgot to respond to the challenge posed the values of  $d_G > 1$  for in Satora and Wegner (2012). If we had, if we had, we would have written as follows:

The case of rainbow trout (*Oncorhynchus mykiss*):

Satora and Wegner (2012) present in their Table 3 estimates of  $d_G$  for rainbow trout which at first sight may appear incompatible, i.e.,  $d_G = 3.443$ , from Morgan (1971) and  $d_G = 0.904$  from several other authors, with the former estimate  $\gg 1$ . However, the range for body weights to which this high value applies is 0.068 to 0.100 g, which corresponds exactly to the expectation from GOLT. Thus, in larval teleost,  $d_G$  is expected to be  $\gg 1$ , then gradually transits to a value  $< 1$ , when the 'head space' occupied by the gills becomes crowded, as occurs here, and as also illustrated for the carp *Cyprinus carpio* (Figure 2 in Pauly and Cheung 2017).

The case of Atlantic horse mackerel (*Trachurus trachurus*):

Satora and Wegner (2012), based on Hughes (1966) present a  $d_G$  estimate of 1.168 for Atlantic horse mackerel *Trachurus trachurus*, ranging in weight from 12 to 135 g. Atlantic horse mackerel reached up to 70 cm, corresponding to slightly above 2 kg (see [www.fishbase.org](http://www.fishbase.org)). Thus, the upper limit of the range of sizes studied so far corresponds with the lower 6.7 % of the realized range of body weight of Atlantic horse mackerel. Given the previous consideration on initially high  $d_G$  values declining with increasing body size, it is not unreasonable to expect that the study of respiratory area in larger specimens would yield a lower estimate of  $d_G$ .]

@54) Why [do you state that key features of the growth of fishes] are well captured by the VBGF? Need to explain.

The phrase "These features [of fish growth] are well captured by the von Bertalanffy growth function..." was modified to "These features are all properties of the von Bertalanffy growth function..." which should do the job, given the preceding and subsequent text.

@55) A correlation between growth and gills does not prove causation. Again, please acknowledge and reveal your thinking on causality. What are the expectations that flow from this correlation, e.g., ontogenetic variation and ablation? While this is laid out in the book [Pauly 2010] at great length, this MS is an opportunity to summarize the book for a different audience rather than berate physiologists like Lefevre et al.

See above for correlation vs. causation. While we cannot "summarize the book" in the few pages of a paper, our choice of examples is an attempt to convince physiologists to look at the evidence we have marshalled. And we don't 'berate' anyone.

@56) A list of questions that can be answered by the authors' gill area limitation theory does not prove in any way that the GOLT is true. This is especially true for points [indirectly related to respiration, and] for which no explanation by the authors is given for how this question relates at all to the GOLT. These questions could have many other answers that are physiologically relevant that have nothing to do with gills. For example, the effect of temperature on chemical reactions in the body could play a big role in answering many of these questions. If these are to be included then raise the hypothesis flowing from the mathematics of gill isometry and provide a summary of the evidence. I fear that this will be a rewrite of the Pauly 2010 book.

One few paragraphs above, this reviewer suggests we treat this submission as "an opportunity to summarize the book for a different audience." Now, he or she "fear[s] that this will be a rewrite of the Pauly 2010 book." Which is it? What we did [by mentioning questions answered by indirectly the GOLT, indirectly related to respiration] is to present some corollaries of the theory which it explains, and which thus help set the orientation of the causal arrow (see above for 'correlation vs. causation').

@57) Explain the choice of using a smaller scaling exponent for larger-bodied fishes.

We did not use a smaller exponent for larger fishes. [Indeed, fishes that can reach larger sizes usually have higher scaling exponents, i.e., values of  $d_G$ ; see also Pauly (2010), and Table 2 in Pauly and Cheung 2017].

@58) Minor Concerns as line-by-line comments. Instead of "oxygen supply to large fish size" do the authors intend "oxygen needed to supply fish to increase in body size."

Agreed. The text now reads “...the oxygen supply to fish of large and increasing size cannot be met by their gills...”

@59) *Do the authors mean “cuts across” instead of “cut-across”*

It means cuts across. This is now corrected.

@60) *Need to put citations [to back certain statements]*

Citations were added.

@61) *Add “or” before “which” and “the scaling exponent ranges” after “which”*

Done.

@62) *Ram ventilation is not the only factor here; see Wegner et al. 2006 Bulletin of Marine Science.*

Sorry, we could not understand what the reviewer suggests we do.

@63) *[Several instances:] “fish” should be “fishes.”*

Corrected.

@64) *See comment above about Wegner et al. 2006 Bulletin of Marine Science.*

Sorry, we could not understand what the reviewer suggests we do.

@65) *[Various typos]*

Agreed; all corrected.

@66) *We do not yet know if whale sharks have large gills RELATIVE to their body size.*

The argument made here does not require the gill of whale shark to be large relative to their body size; in fact, the surface area/body weight in adult whale sharks is probably very low. The issue, rather, is that they live in warm water, which should lead to a high oxygen demand relative to the oxygen supplied by their gills. This is probably the reason why they visit colder deeper waters at regular intervals.

@67) *What is meant by “it must be lower limits below”?*

Thanks for pointing out this error. The sentence, now corrected, should read as follow: “However, it is not reasonable to assume that, as body mass increases, the decrease of maintenance metabolism can continue without limit, i.e., it must have a lower limit, below which a fish’s living cells cannot function.”

### **Reviewer #3**

@68) *Comments to the Author: The response of Pauly and Cheung to Lefevre et al. (2017) raises some important points on an issue that is timely and important. Here I summarize the strengths and weaknesses of their response for the authors’ consideration: Weaknesses: The tone of the manuscript is somewhat snarky in places, which takes away from their more objective arguments. For example [near the end], the authors state sarcastically “this is due to something called scientific progress”. Regardless of the tone of Lefevre et al. (2017), I’d recommend removing this sort of commentary.*

Agreed; we removed the ‘snark’ in the above expression by omitting the words “something called.” This leaves the important remark intact that something cannot be rejected (as Lefevre *et al.* do, incredibly) because it is not in major textbooks.

@69) *The authors never adequately summarize the arguments to which they are responding. A few sentences outlining the central arguments would be helpful.*

Agreed. Lefevre *et al.*’s views are now summarized in the Introduction.

@70) *There is too much reliance on specific species' natural histories / morphologies that appear consistent with the authors' arguments. Some are perhaps worthy of mention in a discussion, but themselves provide little hard scientific evidence.*

We respectfully disagree. As stated above, for a hypothesis to be scientifically interesting, it must explain more than the observations from which it was derived. The wide range of “natural histories/morphologies” that are consistent with that hypothesis can all be seen as tests of that hypothesis, which becomes stronger if it survives these tests, and weaker if it does not. This is in fact the reason why this reviewer, quite naturally, also challenges it with “specific species’ natural histories/morphologies”, i.e., fish species in which the gill apparently scale with body weight  $>1$  (see below).

@71) *Related to the last point, the authors' frequently confound correlation for causation in considering the mass-dependence of gill surface area. For example, the relationships they describe between gill surface area and metabolic rate offer corollary support, but do not firmly establish that gill surface area itself is the primary cause of the body mass scaling of oxygen consumption in fishes. As such, their arguments should be tempered a bit.*

“Corollary support,” when it applies to a wide variety of cases, can become so strong that it shifts the burden of proof with regard to the causality arrow (see our previous take on correlation vs. causation).

@72) *The authors' arguments rely heavily on the implicit assumption that limitations on oxygen supply, rather than oxygen demands, drive oxygen usage. This has been a contentious argument in biology, and thus some brief, but explicit discussion of this assumption may be useful.*

Agreed; we have added a paragraph on this (Note that the assumption that “oxygen usage” (nice expression!) corresponds to oxygen supply, not oxygen demand is not “implicit” in the GOLT. It is rather its central tenet).

@73) *Strengths: The arguments presented using classic growth equations are the strongest evidence presented by these authors. The specific examples given in Table 2 are also informative and convincing. The authors' general point that there must be some matching between morphology and physiology is a point well-taken in the context of this debate. The small, but specific criticisms of Lefevre et al. (2017) in the concluding paragraphs are worth mentioning, apart from the tone.*

Thanks for this. We have softened the tone of the last paragraph.

@74) *The manuscript is clearly written and easy to read.*

Thanks for this – especially in the light of contrary assessment by another reviewer.

## Discussion

The editor to whom this letter was addressed wrote us on the day it was received that it was “[a]n incredibly thorough and considered response to the reviewers and we see no further reason to delay the MS from publication further.” This suggests that taking reviewers seriously, and dealing with the questions they have respectfully and in detail is a winning strategy. However, while we had three largely positive reviews, issues were raised which could have sunk the paper, had we not provided reasonable responses.

The most challenging of these issues, raised by Reviewer #2, was that Table 3.3 of Wegner (2015) reported a scaling factor for the gill area – body mass relationship  $d_G = 1.03$  in the common thresher shark (*Alopius vulpinus*). This was definitely a serious challenge for the GOLT, which claims of that the growth of fishes is limited because  $d_G$  is ‘always’  $< 1$ . In fact, it looked like the famous quote attributed to Thomas Huxley, stating that “[t]he great tragedy of Science [is] the slaying of a beautiful hypothesis by an ugly fact.”

However, (and this might be the result of a tendency toward confirmatory bias), I looked very carefully at the table where this extraordinary value of  $d_G = 1.03$  was listed. At the bottom of this table, I found another value of  $d_G = 0.41$  for the same species, i.e., *Alopius vulpinus*, but linked to a footnote stating that this latter value was “not included [...] due to a limited sample size or a limited body mass size range in comparison to other species.”

Yet the estimate  $d_G = 1.03$  was based on 9 fish, not much more than the 6 upon which the estimate of  $d_G = 0.41$  was based, while the size range associated with  $d_G = 1.03$  (7.9 - 91.5 kg) was actually smaller than the one associated with  $d_G = 0.41$  (60 - 180 kg) [See Figure III].

Thus, it is with a large grain of salt that we must take the *ad hoc* hypothesis of Wegner (2015) that “the high scaling exponent for the gill surface area of the common thresher shark, *Alopias vulpinus* (1.03) may reflect an increased ability for regional endothermy (and hence a disproportionate increase in oxygen demand) (Wootton *et al.* 2015).” Within that framework, a value of  $d_G = 0.41$  would not have been compatible with regional (?) endothermy, and thus it was declared erroneous, although it was the very “ugly fact” that Huxley warned us about.

Conversely, the GOLT has no problem with gills whose surface grows at first as fast as (or even faster than) a volume, i.e., with  $d_G = 1$  (or even  $d >> 1$ ), as long as  $d_G$ , in the course of ontogeny, drops below 1. However, that the transition from  $d_G > 1$  to  $d_G = 1$ , then  $d_G > 1$ , which occurs at in post-larvae/early juveniles in teleosts, should occur at about 1/3 of the maximum sized reached by common thresher shark, *Alopias vulpinus* was not previously known. Moreover, it may apply to other elasmobranchs, as suggested by Table 3.3 in Wegner (2015), which also lists Atlantic stingray (*Dasyatis sabina*) and cownose ray (*Rhinoptera bonasus*) as having ‘wrong’ (=low) scaling values, of  $d_G = 0.20$ . This discovery, which I will follow up on in a future contribution, is entirely due to peer review.

Another insight attributable to this peer review is that I finally realized, after over 35 years, that I used ineffective arguments in my attempts to convince colleagues (ichthyologists, marine biologists, fisheries scientists...) that gills are limiting to animals that breathe water. Rather than argue abstractly that gill areas as a surface, cannot in principle keep up with a volume, I now use, in my lectures and other presentations, objects which scale as a surface, but are functionally related to a volume. One good example is the radiator of a car, which can grow in width and height, but not in depth (Figure III). Another example is that of sieves, whose meshed surfaces can be increased when there is more material to sort, but whose efficiency cannot be increased by stacking. Now, colleagues understand why an ‘oxygen sieve’ whose meshes are made up of gill lamellae can be made larger by increasing its width and its height, but not its depth, because there is little or no oxygen to be extracted from water that has gone through a first ‘layer’ of gill lamellae.

Once the dimensional problem inherent in, e.g., car radiators is fully understood, one can obviously talk about engineering solutions to mitigate its effect. Thus, a propeller turning a high speed in front of a radiator can increase its efficiency, and to a certain extent, obviate the 2-D vs. 3-D problem.

Similarly, hundreds of millions of years have optimized the design of fish gills (see Figure 7 in Pauly 1981, and Ward 2006), so that their effective surface grows, in most (adult) fish, faster than length<sup>2</sup>, i.e.,  $d_G > 2/3$ . This is particularly true for tuna and other large pelagic fishes, in which  $d_G > 0.9$  (or as we have seen above, even  $d_G = 1.03$ , followed by  $d_G = 0.41$ ).

Finally, I must deal with the issue of ‘big data’ as alluded in the Introduction, in spite of the datasets discussed here being very small in comparison with classically big datasets, such as meteorological or genomic data (Pauly 2017).

Here, the issue is that a huge literature exists of where fish live, descend from, and what they do, which ecology, evolutionary biology, genetics, ethology, etc. attempt to make sense of. These sub-disciplines of biology usually proceed by identifying patterns in the data that their practitioners collect, and from these patterns, they derive ‘mechanisms,’ or causal relationships. Such relationships are often correlative at first, then the direction of causal arrows (if any) are identified, usually by a preponderance of evidence on one side. At this point, the formulation of facile *ad hoc* hypotheses of the type illustrate above (“the high scaling exponent for the gill surface area of *Alopias vulpinus* may reflect an increased ability for regional endothermy...”) has to stop. Rather, the discipline in question must be able to identify constraints, i.e., events that are not supposed to occur, observations that are not supposed to be made, and estimates of parameters that are not above or below certain thresholds.

This is understood by all physicists, and constraints of this sort make their discipline strong, and enable it to progress (Platt 1964). Evolutionary biology also has constraints; a crude example would be the fact that we cannot find a fossil rabbit in Ordovician rocks. A moment of reflection suffices to realize that most of what we

know about fish can be re-expressed as constraints. Thus, the ‘law’ (Heincke, 1913) stating that in the North Sea, small plaice (*Pleuronectes platessa*) are found inshore and large plaice offshore (a fact neatly explained by the GOLT, incidentally), can be re-expressed as “in the North Sea, large plaice do not occur inshore” which is a constraint. Thus, if you find a concentration of large plaice inshore, “Heincke’s Law’ would be in trouble.

The GOLT provides strong constraints, and thus an interpretative framework for physiology and various other biological sub-disciplines, including the fast-growing field of global change studies, as the above presentation of the peer review of Pauly and Cheung (2017) may have illustrated. Indeed, this peer review helped solidify the GOLT more than my 35 years of writing about it.

## Acknowledgements

I thank William Cheung for the collaboration which led to the joint paper discussed above, and for his completion of the complex modelling which led to the evaluation of the effect of using a range of  $d_G$  values. I also thank Rainer Froese for numerous discussions on the dimensionality of fish gills, Evelyn Liu for Figures 2 and 3, and the three anonymous reviewers whose crucial inputs form the bulk of this contribution.

## References

- Cheung, W. W. L., Sarmiento, J. L., Dunne, J., Frölicher, T. L., Lam, V., Palomares, M. L. D., Watson, R., & Pauly, D. (2013). Shrinking of fishes exacerbates impacts of global ocean changes on marine ecosystems. *Nature Climate Change* 3, 254-258.
- Cheung, W.W.L., J. Dunne, J. Sarmiento and D. Pauly. 2011. Integrating eco-physiology and plankton dynamics into projected changes in maximum fisheries catch potential under climate change in the northeast Atlantic. *ICES Journal of Marine Science* 68(6): 1008-1018.
- Cheung, W.W.L., J.L. Sarmiento, J. Dunne, T.L. Frölicher, V. Lam, M.L.D. Palomares, R. Watson and D. Pauly. 2013. Shrinking of fishes exacerbates impacts of global ocean changes on marine ecosystems. *Nature Climate Change* 3: 254-258.
- Emery, S.H. and A. Szczepanski. 1986. Gill dimensions in pelagic elasmobranch fishes. *Biological Bulletin* 171: 441-449.
- Fonds, M., Cronie, R., Vethaak, A.D., Van der Puyl, P. (1992). Metabolism, food consumption and growth of plaice (*Pleuronectes platessa*) and flounder (*Platichthys flesus*) in relation to fish size and temperature. *Netherlands Journal of Sea Research* 29(1-3): 127-43.
- Forster, J., Hirst, A. G., and Atkinson, D. (2012). Warming-induced reductions in body size are greater in aquatic than terrestrial species. *Proceedings of the National Academy of Sciences*, 109: 19310-19314.
- Heincke, F. 1913. Investigations on the plaice. General Rapport I. Plaice fishery and protective regulations. Part I. *Rapports et Procès-verbaux des Réunions du Conseil permanent international pour l'Exploration de la Mer*, 17A (1), 153 p.
- Hughes, G.M. (1966). The dimensions of fish gills in relations to their function. *Journal of experimental Biology* 45: 177-195.
- Lefevre, S., McKenzie, D. J., and Nilsson, G. (2017). Models projecting the fate of fish populations under climate change need to be based on valid physiological mechanisms. *Global Change Biology* 23: 3449-3459.
- Liebenberg, L. (2013). *The Origin of Science*. CyberTracker, Cape Town, 266 p.
- Maino JL, Kearney MR. 2014. Ontogenetic and interspecific metabolic scaling in insects. *The American Naturalist* 184(6): 695-701.
- Maino JL, Kearney MR. 2015. Testing mechanistic models of growth in insects. *Proc. R. Soc. B.* 282(1819), 9 p.
- Morgan, M. (1971). Gill development, growth, and respiration in the trout, *Salmo gairdneri*. PhD Dissertation, University of Bristol.
- Pauly, D. (1981). The relationships between gill surface area and growth performance in fish: a generalization of von Bertalanffy's theory of growth. *Berichte der Deutschen wissenschaftlichen Kommission für Meeresforschung* 28(4): 251-282.
- Pauly, D. (1984). A mechanism for the juvenile-to-adult transition in fishes. *Journal du Conseil international pour l'Exploration de la Mer*, 41: 280-284.
- Pauly, D. 1998ab. Tropical fishes: patterns and propensities. p. 1-17. In: T.E. Langford, J. Langford and J.E. Thorpe (eds.) *Tropical Fish Biology*. *Journal of Fish Biology* 53 (Supplement A).
- Pauly, D. (1998b). Why squids, though not fish, may be better understood by pretending they are. p. 47-58. In: A.I.L. Payne, M.R. Lipinski, MR. Clarke, and M.A.C. Roeleveld (eds.) *Cephalopod biodiversity, Ecology and Evolution*. *South African Journal of Marine Science* 20.



- Pauly, D. (2010). Gasping Fish and Panting Squids: Oxygen, Temperature and the Growth of Water-Breathing Animals. *Excellence in Ecology* (22), International Ecology Institute, Oldendorf/Luhe, Germany, xxviii + 216 p.
- Pauly, D. 2017. Big data and the emergence of new 'dissipative' structures *Ethics in Science and Environmental Politics*. doi.org/10.3354/esep00178.
- Pauly, D. and W.W.L. Cheung. 2017. Sound physiological knowledge and principles in modelling shrinking of fishes under climate change. *Global Change Biology*, doi: 10.1111/gcb.13831.
- Platt, J.R. 1964. Strong inference. *Science* 146(3642): 347-353.
- Priede, I. G. (1985). Metabolic scope in fishes, p. 33-64 In: P. Tyler and P. Calow (eds.) *Fish Energetics: New Perspectives*. Croom Helm, London.
- Satora, L. and N.C. Wegner 2012. Reexamination of the Byczkowska-Smik gill surface area data for European teleost, with new measurements on the pikeperch, *Sander lucioperca*. *Rev. Fish. Biol. Fisheries*, 22: 1-9.
- Ward, P. 2006. *Out of Thin Air: Dinosaurs, Birds, and Earth's Ancient History*. National Academies Press / Joseph Henry Press, 296 p.
- Wegner, N.C., C.A. Sepulveda and J.B. Graham. 2006. Gill specializations in high-performance pelagic teleosts, with reference to striped marlin (*Tetrapturus audax*) and wahoo (*Acanthocybium solandri*). *Bulletin of Marine Science* 79(3): 747-759.
- Wegner, N.C. 2015. Elasmobranch gill structure, Chapter 3, p. 101- 151 In: R.E. Shadwick, A.P. Farrell and C.J. Brauner (eds.) *Fish Physiology of Elasmobranch Fishes: Structure and Interaction with Environment*, vol. 34A. Academic Press, Cambridge, Mass.
- Wegner NC, Sepulveda CA, Bull KB, Graham JB. 2010. Gill morphometrics in relation to gas transfer and ram ventilation in high-energy demand teleosts: Scombrids and billfishes. *Journal of Morphology* 271(1): 36-49.
- West, G.B., J.H. Brown and B.J. Enquist. 1997. A general model for the origin of allometric scaling laws in biology. *Science* 276: 122-126.
- West, G.B., J.H. Brown and B.J. Enquist. 2001. A general model for ontogenic growth. *Nature* 413: 628-631.
- West, G.B., V.M. Savage, J. Gillooly, B.J. Enquist, W.H. Woodruff and J.H. Brown. 2003. Why does metabolic rate scale with body size? *Nature* 421: 713.
- Wilson, E. O. (1999). *Consilience: The Unity of Knowledge*. Random House, New York.
- Wootton, T.P., C.A. Sepulveda and N.C. Wegner. 2015. Gill morphometrics of the Thresher Sharks (Genus: *Alopias*). Correlation of Gill Dimensions with Aerobic Demand and Environmental Oxygen. *Journal of Morphology* 276: 589-600.

## MIXED REVIEWS\*

Daniel Pauly

*Sea Around Us, Institute for the Oceans and Fisheries, University of British Columbia, 2202 Main Mall,  
Vancouver, B.C. Canada  
[d.pauly@oceans.ubc.ca](mailto:d.pauly@oceans.ubc.ca)*

### Abstract

This contribution reprints and annotates the reviews, originally published from 1997 to 2012, of 10 books published in the same, or the previous year, on oceanography, marine biology and fishery research. Overall, these 10 reviews give a flavor of the scholarship in fisheries and related fields, including the social science in the late 20th and the early 21st century, as seen from a perspective of a practitioner with a long experience, including a long stint in the tropics.

### Introduction

This essay is similar to its namesake in my first book of essays,<sup>1</sup> where I sought to imitate the “combined review of a dozen books which selected invitees get to do for the *New York Review of Books*.” I do this here, however, by presenting the published review of 10 books, arranged from the most to the least recent. The endnote added to these reviews are marked ‘N.N.’ (for new notes) to distinguish them from those originally published. Here we go:

**ALL THE FISH IN THE SEA: MAXIMUM SUSTAINABLE YIELD AND THE FAILURE OF FISHERIES MANAGEMENT**, by Carmel Finley<sup>2</sup> is a smart little book has all the trappings of a historical account, with endnotes, an extensive bibliography, and a comprehensive index, but it can also be read as a whodunit. The crime scene is the Pacific Ocean, and the motive was access to the fish resources that both Japan and the U.S. were exploiting and/or eyeing, especially salmon in Alaska and tuna in the Pacific, the latter also requiring small bait fishes from coastal waters in Central America.

The victim was good faith - the use of argument based on scientific evidence to articulate legitimate positions. The villain is U.S. foreign policy, specifically its fisheries branch, as personified by an ichthyologist-turned-lobbyist, Wilbert Chapman of the University of Washington. The weapon used for the deed, and the main theme of this book, was the concept of “maximum sustainable yield” (MSY), used against Latin American politicians who objected to the expansion of U.S. tuna fisheries into what later became their Exclusive Economic Zones (EEZs), long before MSY became quantifiable.

Thus, what an amazed reader discovers on page 94 of Finley’s book is that Chapman documented his concept via a tall Gaussian (or bell) curve in a graph with an abscissa labeled “Sustained Intensity of Fishing” and with “Catch of Fish” as an ordinate. MSY was the then the peak of the curve, and it was an unpardonable waste to be fishing near its left tail. Scant attention was given what would happen when the “intensity of fishing” went past that required for MSY, toward the right tail. Indeed, Chapman hardly bothered to elaborate on this, except for asserting that Japan would surely overexploit salmon in Alaska. MSY, however, could not have been estimated at the time it was proposed in this Gaussian form in 1948: it was just a tawdry trick, pulled by Chapman and his acolytes in defense of what was then perceived as of the interests of the U.S. fishing industry.

Finley then shows how the single-species MSY concept became the basis of international fisheries policy - small wonder that fisheries are now globally in trouble.

**ECOSYSTEM-BASED MANAGEMENT FOR MARINE FISHERIES: AN EVOLVING PERSPECTIVE**, edited by Andrea Belgrano and Charles W. Fowler<sup>3</sup>, presumably targets younger marine biologists and fisheries scientists, as its editors define ecosystem-based (fisheries) management as the first step in a required march toward holism. Holism, itself is defined as management that would account for... well, everything. This quixotic claim is not a

---

\* Cite as Pauly, D. (2018) “Mixed Reviews,” Pp. 71-83. *In* Pauly D. and V. Ruiz-Leotaud (eds.) *Marine and Freshwater Miscellanea*. Fisheries Centre Research Reports 26(2). Institute for the Oceans and Fisheries, University of British Columbia.

slip of the pen: we find it repeatedly - in the Preface, in otherwise useful introductions that the editors wrote to tie groups of chapters together, and in their own terminal chapter. Indeed, the editors also want to account for evolution in ecosystems, for which they reintroduce the term “evosystem.” There is even talk of “biosphere-based management and, if only in symbolic form ( $\infty$ ), an allusion to infinity.

How, in an age where we have problems managing comparatively simple systems with enormous stakes (e.g., our international monetary system, or the balance of greenhouse gases in atmosphere), are we ever going to manage marine ecosystems “holistically”? In reality we can only track a dozen species at most, and this imprecisely, for the short periods that they can be turned into exploited resources.

All of this is a real pity because the individual contributions in this book are quite nice reviews, including Alec MacCall’s foreword, which reminds us that the widely used rule of thumb ‘ $F_{MSY} = M$ ’ is “equivalent to saying that at nominally optimal fishing intensities, human predation is equal to all the other predators combined.” Indeed, with regards to the theme of large human impacts, the editors could not have better chosen the first chapter, on the Baltic, which makes very clear that ecosystem considerations are useful in understanding what happens to fisheries, and/or what they can do to the ecosystems in which they are embedded. This is because the Baltic is a very simplified ecosystem shaped from the top down by a few species, notably cod, whose biomass influences the abundance of zooplanktivorous fish and thus that of phytoplankton.

Although several authors complain that many managers view Ecosystem Approaches (EA) as feel-good, annoying complications to the practical business of fishing, this book demonstrates that EA can be tools for greater understanding and better management of fisheries and the ecosystems that nurture them. The various chapters in this book do an excellent job of pointing out, for the ecosystems they document, which component, judiciously chosen, would lead to improved fisheries management and ecosystem resilience. This approach makes the book reviewed here an excellent compendium of case studies.

However, the book does not become a whole, in spite of the editors’ efforts, mainly because it is “holism” that they intend to sell, the whole enchilada, with  $\infty$  and everything, rather than what can be achieved by real scientists and managers, working under time and resource constraints.

Moreover, the fixation on holism has led the editors to overlook howlers, e.g., the notion of a “minimum realistic model,” whose very name is a preposterous claim, and which in this case, would invalidate the whole book if true (if we had minimum *realistic* models, why would be bother with any others?).

Moreover, the editors fail to even begin to address the cost (vs. the benefit) of holism, though this should be possible, since it is feasible to set aside chunks of ecosystems, and watch them recover from the impact of fisheries. But this would involve dealing with the issue of marine reserves, a topic which receives only casual mention in this book - which is a pity, because study after study have shown that mother nature can re-establish some “health,” however defined, in the chunk of ecosystems left in her care, and she does this... holistically.

Overall, I find this book baffling. The holism which the editors seek and to which they insist we must strive is completely unrealistic and not even seriously examined as a philosophical concept, while the individual papers therein are interesting and focused. This is a clear case where the whole is less than the sum of its parts; unholistic.

Here, I would like to add to this review a few comments published in 2009 on "ecosystem-based fisheries management" (EBFM), about which claims are made which are similar to those made for holism<sup>5</sup>.

In the 1970s, when I was a student of fisheries biology in Kiel, Germany, we were taught from textbooks, by Ray Beverton & Sidney Holt, Bill Ricker, John Gulland, and others, which did not mention more than casually the ecosystems within which the exploited species in question are embedded. In fact, these species were presented as having mainly internal dynamics, upon which the ‘outside’, i.e., the ecosystem, could impact only via natural mortality, which was represented by a constant ( $M$ ). It was the same in other countries, and there were reasons for that, perhaps good reasons, but they are no good anymore.

Two related developments led to this extreme reductionism being gradually overcome. One was the inordinate number of exploited fish populations that crashed in the 1980s and 1990s, the most famous of those crashes being that of Northern cod off Eastern Canada, which was supposedly well-managed and whose collapse hugely

impacted on the credibility of fisheries science. The other development was the collateral damage of fisheries, in the form of marine mammals, seabirds and turtles drowned and in form of habitat destruction, both of which became big public issues in that period.

I don't know who first coined the term “ecosystem-based fisheries management” (EBFM), which was proposed as the solution to these ills. But the term was extremely successful, as attested by its acceptance by the environmental NGO community, the public and by various governments, often before their fisheries management agencies could adapt. In fact, the quick acceptance of the term preceded serious scientific discussion of its implications. (It also preceded any consensus on its meaning and feasibility, but this is not a problem as consensus is never achieved on this Earth).

Fisheries scientists and marine ecologists thus had to scramble to give the term some operational definition. Most settled on a list of essentials, including: a place (for the ecosystem to be in), which should be zoned (for different uses), whose integrity (e.g., the sea floor communities) is to be protected from, for example, trawling (at least in part; we are realists), and whose key forage species (e.g., krill, or small fishes) are to be shared between humans and other predators such as marine mammals and seabirds. Also, social scientists have joined in the fray, informing us of such things as “people are part of the ecosystem.” (The quotation marks are a hint that this seemingly platitudinous phrase is anything but, given that it prevents us from conceiving of ecosystems that we would deliberately leave alone).

Out of this scramble came the realization that once an ecosystem becomes the focus of concern, there is no reason to privilege the fisheries, and thus ecosystem-based management (EBM) was born. However, this term hides more than it clarifies. Here is how a major environmental NGO defines “the Principles of EBM” in one of its brochures:

“Ecosystem-based management has objectives and targets that:

- Focus on maintaining the natural structure and function of ecosystems and their productivity;
- Incorporate human use and values of ecosystems in managing the resource;
- Recognize that ecosystems are dynamic and constantly changing;
- Are based on a shared vision of all stakeholders;
- Are based on scientific knowledge, adapted by continual learning and monitoring.”

In other words, EBM as defined here means everything and nothing, i.e., the term has devolved toward vacuity. This is similar to ‘sustainability,’ which could be taken to mean things being done such that they could remain more or less the way they are forever (or at least for a long time). Sustainability then devolved to ‘sustainable growth,’ which is an oxymoron because something that grows (e.g., an economy, or fisheries catches) cannot continue to do so forever or even for a long time. This is in fact neatly illustrated by the unraveling of the various Ponzi schemes of which Wall Street was so fond.

And while we are agonizing about EBM vs. EBFM, and whether humans should be considered in or out, fisheries go on their merry fuel- and subsidy-guzzling ways, smashing deep coral and driving iconic and other species toward extinction. And when fisheries will run out of things to smash and of oil to burn, ocean warming and acidification will complete the job. The difference between EBM and EBFM is not relevant to anything real. What is important is what happens on the ground. We have lots of work to do.

**THE LAST FISH TALE: THE FATE OF THE ATLANTIC AND SURVIVAL IN GLOUCESTER, AMERICA’S OLDEST FISHING PORT AND MOST ORIGINAL TOWN** by Mark Kurlansky<sup>6</sup> is a book whose author follows a formula that has served him well in earlier works on cod, salt, the Basques, and oysters: pick a seemingly mundane maritime topic, dig deep into the historical archive for savory anecdotes, add a sprinkling of cooking recipes and serve it up with a *bon-vivant’s* style.

*The Last Fish Tale* is the story of Gloucester, Massachusetts, the oldest fishing port in the United States. Kurlansky spotlights this New England town to investigate the decline of Atlantic fisheries. He describes Gloucester’s fascinating history, a product of its insularity and island geography, its strong egalitarian identity and the large number of fishers, drawn from a succession of immigrant communities, lost at sea. With rich

ingredients and engaging writing, the book should work. Readers might agree that the loss of yet another diverse, insular culture is bad. But Kurlansky listened to too few voices, and his resulting picture is unbalanced.

My confidence was shaken early in the book. Kurlansky tells us that, in 1602, the explorer and privateer Bartholomew Gosnold remarked that “the fish were far bigger [in New England] than those in the north.” The author repeats this fact throughout the book, even though Gosnold is apparently its only source. Twentieth-century ichthyologists demonstrated that the opposite is true. By studying the maximum sizes of various fishes, they showed that fish grow larger, all other things being equal, in the colder waters at the poleward ends of their range<sup>7</sup>. This matters: sources must be checked against others to avoid drawing the wrong conclusions.

After describing the town and its citizens, the author explains how Gloucester ran out of fish, especially Atlantic cod. The decline of this once-abundant species was partly caused by the success of the schooner-based fishery, which, even though it relied on wind power, caught enough to reduce the population. Bottom trawlers dealt the *coup de grâce*. Kurlansky recalls the introduction of the murderous trawling gear in Gloucester where, as elsewhere, it was first viewed with suspicion, then adopted because its effectiveness was irresistible. This simple explanation should suffice: the cod declined because of overfishing.

Yet Kurlansky demurs, and hints darkly at other causes. When we accompany him to Newlyn, a fishing town in Cornwall, UK, which he presents as Gloucester’s Old World Doppelgänger, we meet fisheries regulators who cannot tell a bass from a cod. “Newlyn vessels had been landing more than their quota of cod, hake, and monkfish by labelling them ling, turbot, and bass - fish for which there were no quotas,” he states. “That it took five years for the regulators to discover this,” Kurlansky says, “indicates how little they know about fish.” Yet it is just as likely that these officials were tolerating an illegal practice, as is common in fisheries worldwide.

Like the Gloucester fishermen, Kurlansky believes that bureaucrats from the US National Marine Fisheries Service cause the problems, not fishing practices. The fish may have disappeared but the fishermen have not, and everybody is looking for the crumbs of a vanished pie. Although the author tells us at length about the antics of the fishermen at Gloucester harbour festivals, such as competitive scrambles along a greasy pole, he does not tell us how, in that same harbour, two fisheries regulators were hanged in effigy in 1999<sup>8</sup>. These officials wanted only to reduce the pressure on vanishing fish, prevent further decline of the resources, and keep the fisheries going.

As Kurlansky’s informants did not deliberately mislead him, this case does not mirror that of anthropologist Margaret Mead misreporting on the sexual mores of Samoan youths. Rather, it is a shared delusion, similar to that of John Edward Mack, the Harvard University psychiatrist who studied people who believed they had been abducted by space aliens. Adopting his subjects’ obsessions, he wrote a book arguing that cosmic kidnap was real.

These are strong words, particularly as I liked and learnt from Kurlansky’s previous books. But *The Last Fish Tale* fails to explain the dual roles of the fishermen as both victims and ferocious drivers of the overfishing behind the collapse of the Gloucester and New England fisheries. Until we recognize these dual roles and the ensuing pathologies, there will be no rebuilding, no renewal of the fisheries.

I suspect that this book, ironically, will find popularity among the tourists who flock to a gentrified Gloucester. Under Kurlansky’s disapproving gaze, they will gradually displace the fishermen, as in most fishing towns around the north Atlantic. Visitors to Gloucester will love the book and the town’s many charming features described in its pages. They will think of the fish and shake their heads at such a loss, still failing to understand.

**THE MOST IMPORTANT FISH IN THE SEA**, by Bruce Franklin<sup>9</sup>, appears at first sight to belong to that lineage which earlier gave us accounts of cod, a.k.a., the fish that changed the world<sup>10</sup>, American shad, i.e., the founding fish<sup>11</sup>, and Patagonian toothfish, also known as Chilean seabass, i.e., the perfect fish<sup>12</sup>. These fish were all important because of their impacts, past or present, on people’s diets. But Atlantic menhaden (*Brevoortia tyrannus*) is really different from cod, shad, and toothfish, because it is a fish that we do not eat and likely never will<sup>13</sup>. Rather, it is eaten by the fishes we like to catch and eat. Thus, the conflicts about and around this fish are different from the conflicts about others, where different people (the French versus the English, the line fishers versus the ones using trawls, etc.) competed for access to wholesome food fish.

With menhaden - an oily, bony, small, and reputedly ill-tasting representative of the herring family - the conflicts have been about the uses, direct or indirect, to which this fish was to be put. Traditionally, menhaden was used

as fertilizer, and the book has an interesting section on how American Indians planted each corn plant with one fish. This role is at the origin of the fish's most common name, *munnaughteaug*, which means "that which manures" in the Algonquian language of the Narragansetts. On the other hand, the larger fish exploited by the early European settlers along the U.S. East Coast, and the marine mammals also abundant along that same coast, all fed on menhaden. This fish, and the microscopic algae it feeds on, formed the base and understory, respectively, of most coastal food webs, from New England to Florida and particularly in Chesapeake Bay.

With the invention of fish meal and its use for feeding chicken and livestock, the industrial fishery for menhaden increased tremendously, especially after World War II. Menhaden, which earlier had formed immense schools, immune to the frenzied hordes of predatory fishes surrounding them, became scarce. Their reduced numbers began to affect the upper part of the food webs, threatening to drag all, prey and predators, into the maw of the reduction plants, which for a time mushroomed along the coast.

Conflict had always simmered between the fishers exploiting larger fish, who wanted menhaden to "fulfill their natural role" (to be eaten by a large fish), and the reduction fishery (which employed spotter planes and purse seiners to save them from such cruel death). The debate intensified in the 1970s, when it was joined by recreational anglers, whose target species (especially striped bass) depended on menhaden - despite assertions to the contrary by spokespersons (some, elected officials) of the reduction fishery.

This fisheries conflict was one of the first that pitted those interested in a single-species approach, hitherto dominant, against advocates of what is now called "ecosystem-based fishery management."<sup>14</sup> The arguments of both sides are still with us, even though (predictably) the bloated reduction fishery, along with the population upon which it depended, largely collapsed. All that is left in the mid-Atlantic region is a small subpopulation of menhaden huddling in Chesapeake Bay and a single firm - the latter a distillate of everything that can be wrong with industrial fisheries (in particular, remote, but well-connected, corporate owners). Further north, off New Jersey and beyond, the now-protected menhaden are coming back. In the Gulf of Mexico, the related Gulf menhaden (*Brevoortia patronus*) still supports an extensive fishery, generating conflicts that trail those along the Atlantic coast by one or two decades.

In the meantime, ecologists discovered that menhaden, given their feeding habits, were fulfilling another ecological role: keeping algal blooms in check. Although the role of oysters in cleaning up coastal waters was always understood, that of menhaden and related filter-feeders was not. Now, people realize that it would be handy to have large schools of menhaden acting as giant vacuum cleaners in Chesapeake Bay and other coastal bodies currently choked by algal blooms triggered by farm runoffs.

*The Most Important Fish in the Sea*, which tells and thoroughly documents these stories, could be seen as yet another helpless commentary on the way we are trashing our oceans. But it is an optimistic book. It deals with a resilient little thing that, unlike larger, longer-lived species such as cod, readily bounces back if given the chance. The role of menhaden in coastal ecosystems is now well understood, making single-species arguments impossible to maintain. And the sole corporation that still fishes Atlantic menhaden for reduction does not have a monopoly in supplying fish meal and fish oil to the market. Indeed, it appears to be able to maintain its fleet only because of the welfare (subsidies) it gets. Perhaps this story will have a positive ending; H. Bruce Franklin's fascinating account makes us look forward to that.

**CORAL: A PESSIMIST IN PARADISE** by Steve Jones<sup>15</sup> is a book which I would have bought if I had first seen it in a bookshop (rather than receiving a review copy). I would have been attracted by its superb cover, whose eerie blue serves as a glorious background for a swimming red snapper. And attempting to casually browse through the text, I would have been slowly ensnared by the loops of its fascinating literary, historic, and scientific digressions.

Any book with the word 'pessimist' in its title must have a sound basis. Here it rests on Charles Darwin's solid shoulders - or more precisely, on his first scientific book, from 1842, *The Structure and Distribution of Coral Reefs*, in which he presented a hypothesis that solved the riddle of how coral reefs grow, where they grow, and why. Jones, in his first chapter, explains how Darwin came to his hypothesis, how it shaped all subsequent research on coral reefs, and how drilling into Pacific atolls, conducted in support of nuclear bomb tests, ultimately confirmed it.



Darwin's book relied on the simple but profound idea that 'lowly' organisms, here coral polyps, pursuing their own tiny goals, through their sheer numbers and over the immensity of time, could play major roles on the geological stage. This is also a theme in his 1859 book *On the Origin of Species*, whose detractors could not fathom the transformative power of small, between-generation changes occurring over eons. This simple idea was again the theme of his 1881 book on the slow, subterranean work of earthworms, *The Formation of Vegetable Mould Through the Action of Worms*, to which he devoted his final years.

Genomics has given us a powerful tool to study the phylogenetic history and affinities of these tiny agents of change. In his second chapter, Jones uses genomics and the hydra (a non-colonial polyp related to corals) to introduce the notion that the cells of hydra cooperate, just like those of people.

They do this, says Jones, because they have learnt from the mutually beneficial relationships of their organelles, many of which are descendants of formerly independent bacteria-like organisms.

He explores this idea further in the third chapter, which is devoted to what appears, in coral reefs and other ecosystems elsewhere, to be disinterested cooperation between species. But it isn't, notwithstanding the benevolent Prince Kropotkin, who gets a loop of several pages. Rather, barely masked warfare prevails, interrupted by tenuous and short truces, revoked when conditions change. Altruism seems to be limited to humans, and one of the biggest tasks we face is to expand our altruistic acts from our circle of relatives, friends and compatriots to the whole of humanity.

Jones then disposes, in his fourth chapter, of the tenacious Western myth of South Pacific coral islands as 'paradise.' Life was too precarious for that, particularly after the first contact with Europeans, who brought previously unknown diseases, some sexually transmitted. The abolition of cannibalism did not compensate for the population losses caused by these scourges.

In his fifth and final chapter, Jones documents the lengthy and rapacious exploitation of coral reefs. He starts with the geological conditions that cause carbon to form extremely hard crystals. In the middle of the nineteenth century, these conditions in parts of what is now India enabled the Maharajah of Hyderabad and his court to trade diamonds, via the East India Company, for jewellery carved from calcium carbonate from Mediterranean corals. Now the East India Company is no more, and these precious corals are mostly gone too.

Jones calls the book's epilogue, entitled '*A Pessimist in Paradise*,' an '*envoi*,' as if it were appended to a poem. He uses it to pull the many strands of this book into one: we are now stuck with trash carbon in the form of carbon dioxide that gums up our atmosphere and, as carbonic acid in sea water, threatens coral reefs, and indeed much marine life, with Armageddon. He explains the physics and chemistry involved with much verve, and more looping (Captain Cook, Australian cockatoos, the Permian extinction, the prospect of 9 billion humans, the Irish Republican Army, California's abalone, Newton, Funafuti Atoll in Tuvalu...).

Finally, he explains his pessimism: "The world of coral gives more reason for despondency than for hope. Local conservation can do little in the face of global change. The future of the reefs is bleak indeed. Their end presages a catastrophe that will spread far beyond their bounds - and remind us that we too are far from safe."

**THE END OF THE LINE: HOW OVERFISHING IS CHANGING THE WORLD AND WHAT WE EAT** by Charles Clover.<sup>16</sup> It has become clear lately - at least to some - that the Earth's resources will not forever accommodate our profligate ways and that something will have to give. Whether cheap oil, water or soils, our use of these precious commodities is unsustainable and some serious accounting will come. (Why is it that one cannot write about such things without sounding like a Sunday-school teacher?) The metaphor of choice is Easter Island. This enigmatic island, littered with giant statues, was deforested by its inhabitants, who reportedly used logs to transport the statues. When the trees were gone, the islanders carved even larger statues, which were expected somehow to move themselves into position. When they, as statues do, failed to move, the islanders went on the rampage, killing one another, burning the remaining wood and overturning the unthankful statues before beginning a century-long descent into destitution (because without trees, there was no means to make boats and, hence, of obtaining seafood, their main source of subsistence). This behavior may be called misguided or even tragic, but one could also describe this as S.T.U.P.I.D. It is one thing to be faced with a difficult ecological problem - say, decreased wheat harvest due to increased soil salinization - but trees? Easter Island is small enough that the man who felled the last tree must have seen that it was the last<sup>17</sup>.

*The End of the Line* is an account of the Common Fisheries Policy, run by the European Commission, and it puts Brussels where it belongs, on Easter Island. As Charles Clover says: “The lunatics have taken over the asylum.” One does not know where to begin: Clover details the scandals of illegal fishing, now a massive industry, our own Medellín cartel right in Europe.

He describes the massacre of dolphins and other protected marine mammals by fishermen who hack them out of their nets<sup>18</sup>; the huge subsidies doled out to the fishing industry; attempts at conservation by European Union scientists who end up ignored, with Brussels-in-Easter-Island issuing quotas that drive one fish population after another into oblivion. It is even true that the fleet decommissioning subsidies, nominally meant to reduce fleet sizes, end up fueling fleet modernization, as the money paid out for retiring one's boat can serve as collateral for the next.

Clover also tells us of the Atlantic Dawn, the largest fishing vessel built, which first operated in EU waters without a fishing license - an intervention by the Irish Prime Minister did the job - before it was deployed in West Africa, where it is now part of the EU fleet that is liquidating what is left of the region's previously abundant resources. The *Irish Times* of December 4, 2004 tells us that it is making a killing in the process.

In fact, don't get Clover started on West African fisheries, or those in eastern Canada, or even about those fishing around Antarctica. Here, as in Europe, the data are unequivocal: fish are subjected to excessive fishing - legally or not - so that their abundance declines, all the way into commercial and, soon, biological extinction. These things are known, and the problem is that in most countries, including those of the EU, politicians are too craven to face the fishing industry.

But Clover heaps the greatest scorn on celebrity chefs, of which he names several. They emphasize their commitment to sustainability and claim to serve fish caught from well-managed fisheries. Yet when he asked how their fish is sourced, he elicited evasive answers or none at all. Clover's conclusion that these cooks are missing an opportunity is, however, mistaken. It is difficult to imagine that one could manage fisheries with our stomachs, that is to say, without primarily involving our brain and, indeed, our heart. The list of fish provided in the appendix that are classified as appropriate for consumption thus could have been omitted. In fact, it is jarring in the context of such an indictment of the fishing industry.

Nevertheless, I found little to disagree with in this book. In fact, the only technical error I found was not in my field, fisheries science, but in one of my avocations, linguistics. Clover, carried away by the beauty of the Newfoundland landscape, suggests that the bakeapple (*Rubus chamaemorus*, also known as cloudberry) got its name from the French "Baie qu'appelle", which, he says, means "what is this berry called?" As a Frenchman, I know this must be Easter Island French. Clover has mis-Google'd himself (French: il s'est mégouglé). The actual origin of the word is Inuktitut (Eskimo).

Getting back to serious matters: it would be nice if one could say that Clover's account of European and world fisheries was exaggerated.

Unfortunately, it is not. It shows, rather, what good journalism can do and what scientists cannot. It is entertaining, outrageous and a must-read for anyone cares about the sea and its denizens, or even about our supply of seafood. Perhaps we can reverse the trends because at present, “the only political influence over the sea's bounty is exacted by an industry - the wild capture fishing industry - which in Britain is roughly the size of the lawnmower industry. No one would dream of allowing the lawnmower industry to dictate the policy of a sovereign state.” For this to happen, however, we have to realize that we are all Easter Islanders, and that there are only a few trees left.

**LINES IN THE WATER: NATURE AND CULTURE AT LAKE TITICACA** by Benjamin Orlove<sup>19</sup>, is well-written and will be an excellent source of facts to anyone interested in the fishers and fisheries of Lake Titicaca, and how the former have managed to maintain the latter in spite of centuries of pressure from outside.

And I could stop here, without commenting on the fact that most of us - let's face it - do not necessarily care much about what happens in and around Lake Titicaca. Thus: just how is this book going to attract the broader audience that it deserves? This is equivalent to posing the question of how the book deals with general issues, a topic Orlove addresses directly only once (p. 224), when he states that “anthropologists are supposed to generalize from particular cases.”

But he does not follow up on this; rather, as most anthropologists appear to do (at least to this lay reader of their books), he uses bits of knowledge from other places to interpret what happens around Lake Titicaca, without returning new, broader insights, much as a black hole that feeds on the surrounding matter, without regurgitating anything back out.

But the analogy is misleading: black holes crush what they ingest, leaving nothing like the exquisite details to be found in this book, which attempts to document what the folks around Lake Titicaca do, and presumably think. Thus, the black hole analogy would make us overlook that Orlove presents these acts and thoughts as things that we “Westerners” would not do or think.

It is there that Orlove reminds one of the 1970s US TV series ‘Mork and Mindy,’ wherein Mork, a space alien in human form (young Robin Williams) kept stumbling over our human conventions and ways of doing things, because they did not match those of his home planet. Thus, in Morkian fashion, Orlove devotes a large chunk of his first chapter (‘Not forgetting’) to explaining how much the villagers insisted he should not forget them after his departure, a theme he illustrates with Quechua and Spanish-language romantic songs, full of allusions about forgotten and betrayed love, an expression of their fear of being devalued by their government and the dominant culture it represents. As if other cultures – including that of the ‘West’ – did not have forgetting as one of their major themes, with, e.g., Penelope and Proust attempting, both in their own way, not to forget.

Or we read, in Chapter 4, on ‘Work,’ that the notion of time the villagers rely on is flexible, and differently valued in different parts of the day, and different seasons, while “Western time” is supposedly “homogenous” and “linear” (‘linear’ is bad and Western, and always pops up in such books), as if the working hours of those Westerners having to toil for an assembly lines did not drag on, while their weekends end too quickly. And he wonders why “the villagers do not count eating as work,” as if anybody but corporate lawyers had billable ‘power lunches.’ Or we read that the villagers value work differently, depending on whether a new “product,” say an adobe house, is generated, while repair work, e.g., mending a net is not; also, most women’s work does not count. As if it were not exactly the same in the West, where healthy, well-fed children do not count as “products” that required work to produce. Then Orlove wonders why the villagers do not maximize their short-term economic returns, as if anybody but the CEOs of Enron Corporation and similar fly-by-night operations were doing anything as stupid as that.

Unlike Mork, Ben Orlove eventually returned to his mothership, the University of California at Davis, part of a system that has sent us many visitors, most of them failing to report to their leader that, for all our diversity, we are, throughout the world, a rather similar bunch, with largely predicable responses to the challenges that living on Earth imply. Some of these responses, sadly, generate the same new set of problems, as illustrated in the chapter on ‘Fish:’

- Extinction of at least one species of endemic fish, while the introduction of another exotic fish, the silverside, led to the establishment of a parasite now causing kills among the remaining native fish species;
- Cage culture of carnivorous fishes is also bad news, and leads to pollution and waste of the smaller fishes used as feed, and previously used for fish introductions are usually bad news: the trout introduced into the lake, while fuelling a short-lived boom of canning and exports caused the human food;
- The inevitable spread of more effective fishing gear – to which, he points out, our author as himself contributed – lead inevitably to gradual depletion for the underlying fish populations, particularly among large, longer-lived fishes, leading to fishing down the food web<sup>20</sup>; and
- Setting up marine parks without involving the local people leads to active sabotage and ‘paper parks.’

These generalities may be boring, but they cover issues that must be addressed everywhere. Orlove’s book will help those that will try to address these issues around Lake Titicaca. Unfortunately, its author did not extend to the ‘Lines’ of his title and the ‘Paths’ of his last chapter to other people, and especially not to us ‘Westerners.’

**ECOLOGICAL GEOGRAPHY OF THE SEA** by A. Longhurst<sup>21</sup> is a book for which many have been waiting for. As pointed out in its introduction, a ‘geography of the sea’ – that is, a rigorous definition of ‘provinces’ suitable for describing, in standardized fashion, the distribution of all marine organisms – did not exist despite a history of oceanographic research starting with the Challenger Expedition (1872–1876). Numerous maps did exist in which

this or that oceanographic parameter or the distribution of a few organisms had been used to draw provinces or 'Large Marine Ecosystems' (LME) of some sort. However, no test had been conducted of the ability of these proposed maps to predict distributions other than those from which they were derived: circularity reigned supreme.

Reasons for this are easy to imagine, from the excessive preoccupation of various specialists with their favorite taxonomic groups to the absence, before the recent computer revolution, of analytical tools up to the task. However, the real reason is probably that developing a truly synoptic vision of the ocean was impossible before the advent of satellite-based oceanography. Satellites cannot see very deep into the sea, nor can they see very much – at least as far as those satellites are concerned that civilians know about.

However, what satellites do see is the very stuff that generates fundamental differences between ocean provinces: sea surface temperatures and their seasonal fluctuations, and pigments such as chlorophyll, and their fluctuations. Marine systems differ from terrestrial ones in that their productivity is essentially a function of nutrient inputs to illuminated layers. This gives a structuring role to the physical processes that enrich surface waters with nutrients from deeper layers, such as wind-induced mixing, fronts, upwellings, etc. Thus, the location, duration and amplitude of deep nutrient inputs into different oceanic regions (as reflected in the abundance of their chlorophyll, and described in *Ecological Geography of the Sea*) largely define the upper trophic level biomasses and fluxes that can be maintained in these regions. This is the reason why satellite images reflect fundamental features of the ocean, whereas maps based on the distribution of various organisms – even 'indicator' organisms – can only reflect second-order phenomena.

Alan Longhurst is among the very first to have fully realized these implications of satellite oceanography, and to have followed up on them. This led to an estimate of global marine primary production much superior to earlier attempts<sup>22</sup>, based on a stratification by 'provinces' defined in another major contribution<sup>23</sup>. Then Alan Longhurst went into retirement to run an art gallery in southern France with his wife.

The book presented here was written thereafter, largely by popular demand: many colleagues adopted the provinces proposed in these earlier works as standard for work now published<sup>24</sup>, or still in preparation, but wanted more details on what it was obvious to call 'Longhurst Areas'<sup>25</sup>. For example, Longhurst Areas will provide the architecture for several projects in which I am involved, whose products are expressed on a global basis. This will involve stratifying global marine fish biodiversity in forthcoming releases of FishBase ([www.fishbase.org](http://www.fishbase.org)).<sup>26</sup> It will also involve replacing the 18 'FAO Statistical Areas' currently used for raising upper trophic level biomass fluxes from local ecosystem models to regional estimates, and thence to the global ocean.<sup>27</sup>

This work will be aided not only by the existence of Longhurst's classification of ocean provinces – whose reliability can be assessed in the first 98 pages of the book, which discusses conceptual and methodological issues – but also by the detailed description of the 51 neritic and oceanic provinces presented in the next 300 pages. The work of various research groups will undoubtedly modify these descriptions. However, most of this follow-up work will only add details to one or other Longhurst Area. The excellence of this book guarantees that the overall structure will remain, and that the well-deserved eponym will stick.

**TROPICAL ESTUARINE FISHES: ECOLOGY, EXPLOITATION AND CONSERVATION**, by S.J.M. Blaber<sup>28</sup>. One question that should be asked more often is 'What becomes of the flood of intermixed facts, factoids, and gems in the thousands of papers – many of them 'just publishable units' - on the food and feeding, distribution and migration, and growth and reproduction of fish one finds scattered in an ever-growing number of journals?' One gets the impression that only a large asteroid impact could stem this flood: too many theses have to be written, and too many academic promotion committees count papers for this to happen otherwise.

Fortunately, there are ways to make sense of this flood, and to channel the evidence it carries toward deeper insights and knowledge on the ecosystems in which the fish in question live. One of these solutions is to write books such as Blaber's excellent *Tropical Estuarine Fishes*, whose various chapters [...] use a formidable amount of evidence to buttress the key thesis that tropical estuaries are distinct and highly productive, but also rather fragile ecosystems.

The book thus assembled, also shows one important aspect of what we should do when studying biodiversity - something we talk about a lot, but rarely engage in. Analyzing and reporting on patterns of biodiversity is what

Blaber has done here, all quite masterly. In the process, he has also shown how, in a given set of ecosystems, different species, while doing their own thing, have ended up constructing systems of mutual dependence, with each contributing its bit to something that is far more than the sum of its parts - just like this book. Analyzing biodiversity thus begat understanding of ecosystem functioning, which then begat a well-rounded book.<sup>30</sup>

**PATTERNS IN THE OCEANS: OCEAN PROCESSES AND MARINE POPULATION DYNAMICS** by Andrew Bakun<sup>31</sup> has a title which sounds just like one of those thematic collections of reprints *Scientific American* publishes, with long forewords and introductions vainly attempting to force some order into an incoherent whole. Not so here: the title means something, i.e., the book really deals with ‘patterns,’ and how these shape the population dynamics of marine organisms. In fact, patterns are so important to this book that the author presents his own, evolutionary explanation for the fact that we humans enjoy identifying deeper and deeper patterns, e.g., in music or literature.

Patterns, in this book, occur at two levels, one dealing with the way we know things about the ocean, and which may be called ‘epistemological,’ the other dealing with the way things ‘are,’ and which may therefore be called ‘ontological’. At the epistemological level, patterns are crucial because, as Bakun emphasizes, we cannot perform experiments involving large-scale fluctuations of ocean regimes or fish population sizes (except for our changing the global climate, an unplanned experiment), and hence we must rely on the comparative method to tease out insights from data, e.g., on patterns of similarities. Here the danger is that we commit the fallacies involved, for instance, in most correlational studies of fish recruitment, which happily convert pattern of association into cause-and-effect relationships.

To avoid this circularity, one’s understanding of the ocean must truly reflect its underlying patterns, e.g., of circulation, and this leads to the only tedious - if necessary - part of this otherwise entertaining book, in which Bakun takes us “beyond [our] experience” as terrestrial dwellers with limited ranges (airplanes notwithstanding), and presents the “different rules” which determine how water currents flow, and/or which determine how marine organisms move, breathe and feed. A deep knowledge of these rules, frequently counterintuitive, and too often unknown to marine and fisheries biologists, is what has made Andy Bakun the world’s leading fisheries oceanographer. And before one can enjoy this profound book, one must understand these rules, just as a knowledge of music can enhance one’s appreciation of great musical work.

Epistemological and ontological patterns meet repeatedly in this book - or less pompously: there are in this book several sections in which explanations based on the comparative method succeed in explaining an extraordinarily wide range of phenomena. The most prominent of these is the presentation of Bakun’s ‘triad hypothesis’, the claim that large, productive fish populations require the occurrence of areas in which processes of (plankton) enrichment, concentration and (fish larvae) retention can occur. Simple as it may sound, this hypothesis has led to an outburst of new insights on the use, by fish, of fronts and other oceanic features. Many of these, by Bakun and his long-term collaborator Richard Parrish, are presented, as are related developments by Claude Roy and Philippe Cury (ORSTOM, France), whose discovery of dome-shaped recruitment ‘windows’ in clupeoids of upwelling systems is highlighted.

Much of the book is devoted to the identification of triad patterns in different parts of the world’s oceans, and of the mechanisms - some well-known, some rescued by Bakun from obscure physics journals - of physical mechanisms underlying triads: stratified Taylor columns, Lasker events, Langmuir circulation, Kelvin waves and other eponyms. We should let these concepts enrich our vocabulary, concentrate our research on them, and retain those that prove their mettle.

The most ambitious part of the book deals with global patterns, the often simultaneous, decadal shift of regimes which appear to have affected many small pelagic fishes throughout the world, and the global shift, induced by our climate changing ways, that these regimes presage. Here, I believe, we reach the limits of Bakun’s and of our pattern-recognition ability. The patterns are too faint, and the time series too short to generate more than an ominous feeling that the fine-tuned triads upon which many of our important exploited populations depend will come unraveled as global changes shift the geographic location of fronts and other oceanographic structures.

I am not a dispassionate Bakun-watcher: we have been friends since 1980 and we have argued about many of the key ideas in this book. On the other hand, I teach a Philosophy of Science course, and can tell a good story when I see one: a few simple, largely unarguable points are used to explain an extraordinarily wide range of phenomena,



with enough work left for younger scientists to follow-up, while older, less successful colleagues argue it is all wrong, that things are much more complicated than that. Just like *Origins* - and I don't mind being Bakun's Huxley.

## Endnotes (N.N. refers to new notes; see Introduction)

---

<sup>1</sup> N.N. Pages 189-202 In: Pauly, D. 1994. *On the sex of fish and the gender of scientists: essays in fisheries science*. Chapman & Hall, London, 250 p.

<sup>2</sup> N.N. The full reference is Finley, C. 2011. *All the fish in the sea: Maximum sustainable yield and the failure of fisheries management*. University of Chicago Press, Chicago, xii + 210 p. My review of it was published in 2012 in *The Quarterly Review of Biology*, 87(2): 168.

<sup>3</sup> N.N. The full reference is Belgrano A. and Charles W. Fowler (Editors). 2011. *Ecosystem-based management for marine fisheries: an evolving perspective*. Cambridge University Press, New York, xvii + 384 p. My review of it, titled "Even holism is not enough" was published in 2012 in *Ecology* 93(4): 952.

<sup>4</sup> N.N. This can be read as "the fishing mortality which when applied consistently will produce maximum sustainable yield is equal to the natural mortality of the population in question."

<sup>5</sup> N.N. Pauly, D. 2008/2009. On Marine Ecosystems, Fisheries Management and Semantics. *Marine Ecosystems and Management*, 2(2): 5.

<sup>6</sup> The full reference is Kurlansky, M. 2008. *The last fish tale: The fate of the Atlantic and survival in Gloucester, America's oldest fishing port and most original town*. Random House/Jonathan Cape, 304 p. My review of it, titled "The End of the Line?" appeared in *Nature*, 453: 1180-1181, in 2008.

<sup>7</sup> N.N. The reason is that colder temperature, by reducing the metabolic rates of fish, allows them to reach larger sizes, see Pauly, D. 2010. *Gasping fish and panting squids: oxygen, temperature and the growth of water-breathing animals*. International Ecology Institute, Oldendorf/Luhe, Germany, xxviii + 216 p. If you can't get this book, look at Gunter, G. 1950. Correlation between temperature of water and size of marine fish on the Atlantic and Gulf Coast of the United States. *Copeia*, 4: 298-304.

<sup>8</sup> N.N. One of these two persons is a good friend, and I know he meant well with the Gloucester fisheries. I don't like to hear of my friends being burned, even if in effigy.

<sup>9</sup> N.N. Franklin, B. 2007. *The most important fish in the sea*. Island Press, Washington DC. My review of it, titled "Tales of a small, but crucial fish" was published in 2007 in *Science*, 318: 750-751.

<sup>10</sup> See: Kurlansky, M. 1997. *Cod: a biography of the fish that changed the world*. Walker, New York, 294 p.

<sup>11</sup> See: McPhee J. 2002. *The founding fish*. Farrar, Straus and Giroux, New York, 358 p.

<sup>12</sup> See: Knecht, G.B. 2007. *Hooked: pirates, poaching, and the perfect fish*. Rodale, New York, xii + 278 p.

<sup>13</sup> N.N. Since this was originally written, I have eaten menhaden in September 2016, at the New York home of Paul Greenberg (author of *Four fishes: the future of the last wild food*), and they were fine. The menhaden's reputation is a result of the same propaganda that had declared the Peruvian anchoveta 'inedible.'

<sup>14</sup> Pikitch, E, C. Santora, E.A. Babcock, A. Bakun, R. Bonfil, D.O. Conover, P.A. Dayton, P. Doukakis, D. Fluharty, B. Heneman and E.D. Houde. 2004. Ecosystem-based fishery management. *Science*, 305: 346-347.

<sup>15</sup> Jones, S. 2007. *Coral: A pessimist in paradise*. Little Brown, London, 242 p. My review of it, titled "Trouble in Paradise," was published in *Nature*, 447: 33-34, in 2007.

<sup>16</sup> N.N. Clover, C. 2004. *The end of the line: How overfishing is changing the world and what we eat*. Ebury, London, 386 p. My review of it appeared on April 22, 2005 in *The Times Higher Education Supplement*, p. 28, but it was drafted a few days after I had a stroke. I was anxious to check if my brain still functioned. It did. I



should also mention that *The end of the line* was turned in a film of the time title, released in 2009, in which I which I was pleased to participate.

<sup>17</sup> N.N. This conventional account of the ecological history of Easter Island, or better Rapa Nui, is contested by a number of archeologists (it is rats that ate the seeds of the trees, the statues were not rolled on tree trunks, etc.). Still, it is the Rapa Nui that fought resources wars on an island 25 km long, with the result that their population, which may have exceeded 20,000 at a time, was reduced to a few hundred when Peruvian slavers, in the 1860s abducted most of the remaining population. One can only rejoice that the Rapa Nui escaped annihilation, and are rebuilding their population and Polynesian culture.

<sup>18</sup> N.N. An account of these activities in the North Sea is given in the opening chapter of the British edition; the US edition starts instead with the sad state of the New England fisheries.

<sup>19</sup> N.N. Orlove, B. 2002. *Lines in the water: Nature and culture at Lake Titicaca*. University of California Press, Berkeley, xxvii + 287 p. My review of it, titled "An alien abroad" was published in October of the same year (although not in full) in the *New Scientist*, (2364): 55.

<sup>20</sup> See Holmes, B. 1998. The rape of the sea: fishing fleets are rampaging their way down the marine food chain. *New Scientist* 157(2121):4.

<sup>21</sup> N.N. Longhurst, A.R. 1998. *Ecological geography of the sea*. Academic Press, San Diego, xii + 398 p. My review of it we published in 1999 in *Trends in Ecology and Evolution* 14(3): 118. Note that a second edition of this book was published in 2006 by Elsevier.

<sup>22</sup> Longhurst, A.R., S. Sathyendranath, T. Platt and C. Caverhill. 1995. *Journal of Plankton Research* 17:1245-1271

<sup>23</sup> Longhurst, A.R. 1995. Seasonal cycles of pelagic production and consumption. *Progress in Oceanography* 36: 77-167.

<sup>24</sup> Fonteneau, A. 1997. *Atlas of tropical tuna fisheries*. ORSTOM, Paris

<sup>25</sup> Pauly, D. 1998 Large marine ecosystems: analysis and management. p. 487-499 In: S.C. Pillar, A.I.L Payne, and F.A. Shillington (eds.) *Benguela dynamics: impacts of variability on shelf-sea environments and their living resources*. South African Journal of Marine Science 19.

<sup>26</sup> N.N. A subsequent, detailed analysis of the similarities and differences of Longhurst Areas and the system of Large Marine Ecosystems then advocated by Ken Sherman of NOAA (Pauly, D., V. Christensen, R. Froese, A. Longhurst, T. Platt, S. Sathyendranath, K. Sherman and R. Watson. 2000. Mapping fisheries onto marine ecosystems: a proposal for a consensus approach for regional, oceanic and global integration. p. 13-22. In: D. Pauly and T.J. Pitcher (eds.) *Methods for Evaluating the Impacts of Fisheries on North Atlantic Ecosystems*. Fisheries Centre Research Reports 8(2).) suggested that, for pragmatic reasons, we should rely on the latter system for fisheries data (see [www.seaaroundus.org](http://www.seaaroundus.org)), and on altogether smaller ecosystems from FishBase (see [www.fishbase.org](http://www.fishbase.org)).

<sup>27</sup> Pauly, D. and V. Christensen. 1995. Primary production required to sustain global fisheries. *Nature* 374: 255-257. [Erratum in *Nature* 376: 279]

<sup>28</sup> *Tropical estuarine fishes: Ecology, exploitation and conservation* by S.J.M. Blaber, 2000. Blackwell Science, Oxford, xii + 372 p. My review of this book was published in 2001 in *Fish and Fisheries* 2(4): 385. I spare the reader an earlier book by the same author, i.e., *Fish and fisheries of tropical estuaries* Chapman & Hall, London (1997), my review of which was published the same year in *Reviews in Fish Biology and Fisheries* 7(4): 493-494. This would be expecting too much of the patience that you, Dear Reader, have exhibited if you have read so far.

<sup>29</sup> N.N. These chapters, originally listed in my review were titled: 'diversity of tropical estuaries'; their 'fish faunas and communities'; their 'trophic ecology', 'reproductive strategies'; 'effect of structure on hydrology'; 'mangrove or estuarine dependence', and 'human impacts (fishing, agriculture, industry, climate change)'.

<sup>30</sup> N.N. the actual ending of the review was: "Now to the guidelines given to book reviewers: Yes, the material is extremely well selected and organized; Yes, the arguments are clear and logical, and the statements of facts are

accurate; Yes, the book is sturdy and well bound, and its many figures, mainly drawn by Stella Barber (let's give credit where credit is due) are clear and convey their message very well; The readership: any student or scientist working on tropical estuarine (and coastal) fishes must have this book.”

<sup>31</sup> Bakun, A. 1996. *Patterns in the oceans: Ocean processes and marine population dynamics*. California Sea Grant, La Jolla, CA, and Centro de Investigaciones Biológicas del Noroeste, La Paz, BCS, Mexico. My review of this book was published in 1997 in *Reviews in Fish Biology and Fisheries* 7: 382-384.